

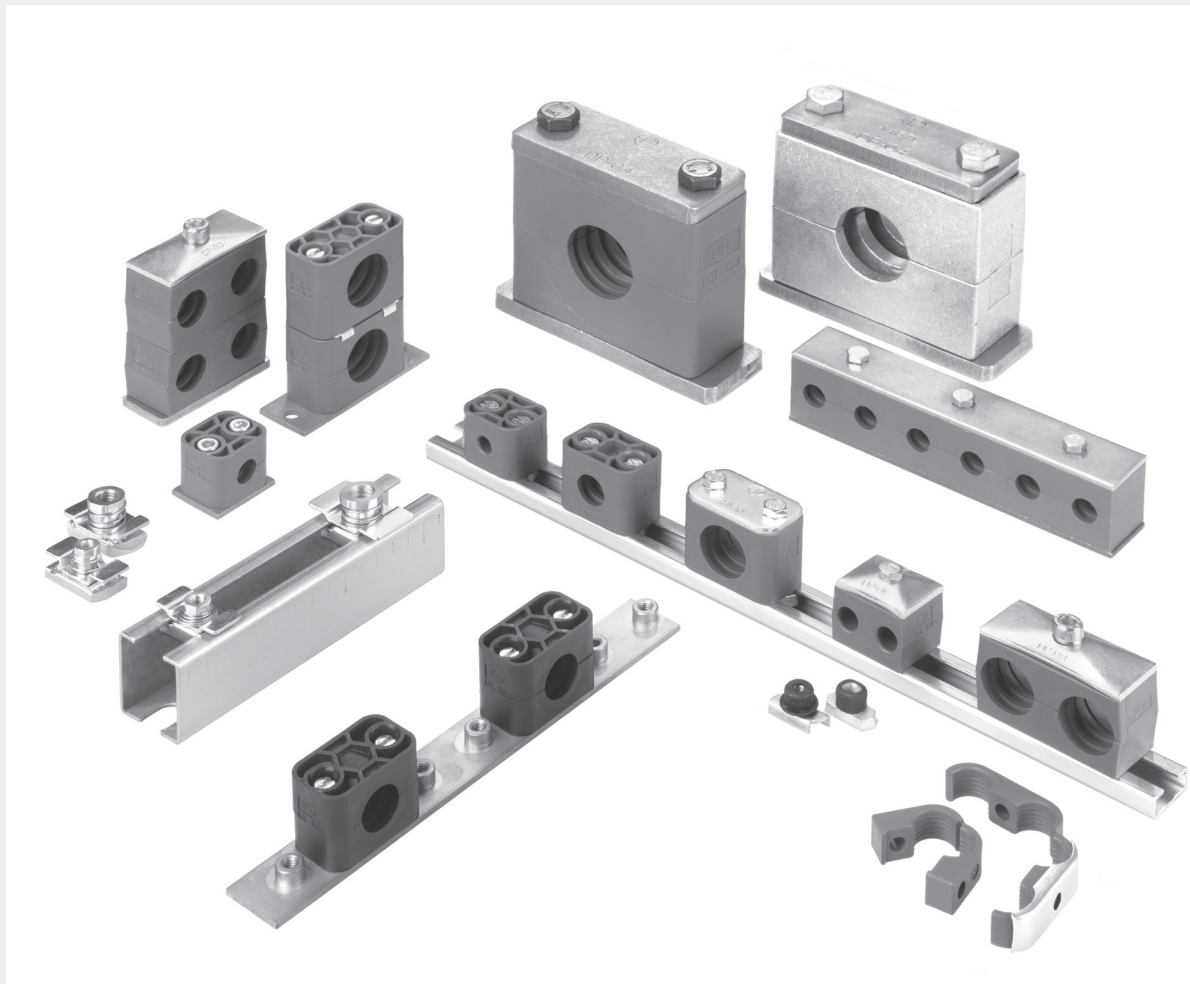



EO[®] Ermeto Original *Tube clamps*



Content

Technical data T3
 Material properties T4
 Special materials T5
 Assembly instruction T6

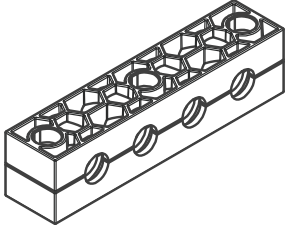
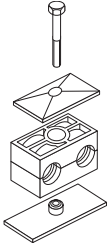
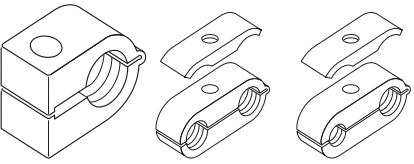
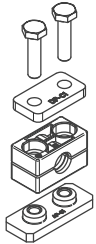
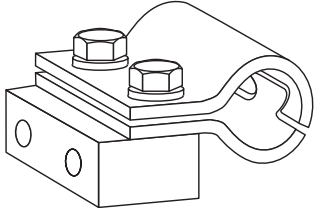
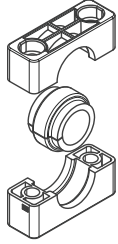
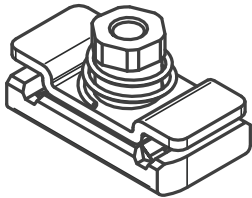
<p>Series A Light series (DIN 3015-1)</p>	 <p>T8-T23</p>	<p>Multiclamps</p>	 <p>T38-T43</p>
<p>Series B Double series (DIN 3015-3)</p>	 <p>T24-T28</p>	<p>Series O</p>	<p>single double</p>  <p>T44-T45</p>
<p>Series C Heavy series (DIN 3015-2)</p>	 <p>T29-T37</p>	<p>Hydraulic steel clamps</p>	 <p>T46-T47</p>
		<p>Tube clamps with Elastomer inlay</p>	 <p>T48-T50</p>
		<p>Fixed adaptor</p>	 <p>T51-T54</p>

Tube clamps

DIN 3015

Programme:

Tube clamps series A (according to DIN 3015 Part 1)

Available in nine standard sizes for normal mechanical requirements.

- Outer tube diameter for the metric series 4 to 101.8 mm
 - Outer tube diameter for the inch-size series R 1/8" to R 3 1/2"
 - Outer tube diameter for the imperial size series 1/4" to 4"
- Accessories and construction types

Tube clamps series B (according to DIN 3015 Part 3)

Available as a twin tube clamp in five standard sizes for normal mechanical requirements.

- Outer tube diameter for the metric series 6 to 42 mm
 - Outer tube diameter for the inch-size series R 1/8" to R 1 1/4"
 - Outer tube diameter for the imperial size series 1/4" to 1 1/2"
- Double tube clamps with different tube o.d. are available on request.

Accessories and construction types

Tube clamps series C (according to DIN 3015 Part 2)

Specially designed for high mechanical requirements, and available in ten standard sizes.

- Outer tube diameter for the metric series 6 to 406.4 mm
 - Outer tube diameter for the inch-size series R 1/8" to R 16"
 - Outer tube diameter for the imperial size series 5/16" to 12 3/4"
- Accessories and construction types

Design:

According to DIN 3015:

Both upper and lower clamp-halves are identical.

Webs inside the bore of the clamps provide an impact and vibration deadening effect, and absorb the forces towards the direction of the tube axis.

For mounting hoses and cables it is recommended that clamps with a smooth interior surface and without prestress (block height C is reduced by gap height S) are used.

Clamp material:

Polypropylene	-30°C up to + 90° C	colour dark green
Polyamide	-40°C up to + 120° C	colour black
Rubber	-50°C up to + 120° C	colour black
Aluminium	-40°C up to + 300° C	

Stainless steel upon request.

Non standard colours upon request.

Special materials

Flame retardant.....p. T5
Corrosion retardant..... p. T5

Resistance to stress:

The remarkable features of **Tube Clamps** are their considerable re-set capability, high tensile strength, as well as their very high output strength and excellent resistance to cold. The choice of design and clamp material depends on the specific demands of the mechanical and thermal requirements.

Order code:

The order code for clamp halves as well as the reference No. for complete tube clamps incorporates the serial indication, material description and interior surface.

In accordance with DIN 3015, clamps always consist of two clamp halves. (1 clamp = 2 clamp halves)

Example of description:

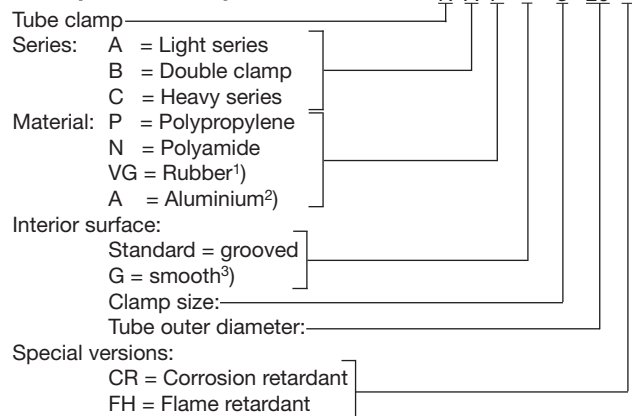

- ¹⁾ Rubber only available for series A and B, inside smooth and series C grooved design (G).
- ²⁾ Aluminium only available for series A size 0 to 6 and series C size 1 to 8. Aluminium clamps only available in a grooved design.
- ³⁾ Inside smooth series A not for size 0.
Inside smooth series C only up to size 8.
Clamps with smooth interior surface and without prestress

Finish of the metal components:

All metal components are available in steel and stainless steel.

Stainless steel quality:

Stainless steel W5 (1.4401 or 1.4571) from stock, W4 (1.4301 or 1.4305) available on request.

Surfaces steel:

As is standard, the steel components have the following surfaces:

Metal part	Series A+B		Series C	
	Bolt	Cr(VI)-free zinc plated		phosphated
Cover plate	Cr(VI)-free zinc plated		phosphated	Cr(VI)-free zinc plated
Welding plate	phosphated		phosphated	
Mounting rail nut	Cr(VI)-free zinc plated		Cr(VI)-free zinc plated	
Mounting rail	plain & oiled	Cr(VI)-free zinc plated	plain & oiled	Cr(VI)-free zinc plated

Surfaces differing from this are available on request.

Registration:

On request.

Tube clamps material properties

DIN 3015

Mechanical properties	Polypropylene (PP)	Polyamide (PA)	Aluminium (Al)	Rubber (TPE)
Density	0.90 g/cm ³	1.10 g/cm ³	2.65 g/cm ³	0.97 g/cm ³
Impact value at 23 °C	7 kJ/m ² (ISO 179/1eA)	8 kJ/mm ² (ISO 179/1eA)	–	–
Impact value at -20 °C	3 kJ/m ² (ISO 179/1eA)	–	–	–
Modulus of elasticity	1.400 N/mm ² (ISO 527)	2.000 N/mm ² (ISO 527)	72.000 N/mm ²	–
Yield stress. resp. tensile strength (Rm)	28 N/mm ² (ISO 527)	50 N/mm ² (ISO 527)	>240 N/mm ²	5.2 ... 8.8 N/mm ² (ASTM D412)
Thermal properties				
Temp. resistance	-30 ... +90°C	-40 ... +120°C	-40 ... +300°C	-50 ... +120°C
Chemical properties				
Weak acids	limited resistant	limited resistant	limited resistant	resistant
Weak alkalis	limited resistant	limited resistant	limited resistant	resistant
Alcohol	resistant	resistant	resistant	resistant
Petrol	limited resistant	resistant	resistant	limited resistant
Mineral oils	limited resistant	resistant	resistant	resistant
Other oils	resistant	resistant	resistant	resistant
Sea Water	resistant	resistant	limited resistant	resistant

The outlined particulars are approximate values and are only shown for reference, which are not binding, and with regard to possible protection of third parties. They do not exempt you from your own examination of suitability of the products delivered by us. Therefore, these values can only be used in a limited way for guidance only.

The application of the products is carried out outside of our control and, therefore, is exclusively subject to your own area of responsibility. Any claim however would be limited for all damages to the value of the goods supplied by us and in use by you.

It goes without saying, that we guarantee the perfect quality of our products according to our general sales and delivery conditions.

Special materials

Flame retardant clamps for railway vehicles EN 45545-2

Our flame retardant finish is the ideal solution for the transport and railway market. This provides increased safety and efficiency for railway vehicles.

Material:	Polypropylene (PP-F)	Polyamide (PA-F)	Rubber (TPE-F)
T01 EN ISO 4589-2: Oxygen Index	OI = 38.7 %	OI = 35.5 %	OI = 33.4 %
T10.03 EN ISO 5659-2: 25 kW/m ²	D _S max. = 48	D _S max. = 124	D _S max. = 79
T12 NF X 70 100-1 & -2: 600°C	CIT _{NLP} = 0.15	CIT _{NLP} = 0.51	CIT _{NLP} = 0.15
Compliance of the requirement set R22, 23, 24, 26 for the hazard level:	HL1 - HL2 - HL3	HL1 - HL2 - HL3	HL1 - HL2 - HL3

The advantages:

- Improved railway vehicle safety
- Flame retardant in accordance with DIN 45545-2, UL 94, DIN 3015, BS 6853, DIN 5510-2, NF F 16-101 NF F 16-101, BS 6853, UL 94
- 2+5 system. Only 2 sizes for tube diameters 6-42 mm
- Plates and rails in steel and stainless steel

Standard compliance:

Flame protected tube clamps DIN 3015 certification in line with:

- BS 6853
- DIN 5510-2
- DIN EN 45545
- UL 94
- NF F 16-101

For the original material polypropylene, the color of the clamp is white, black for polyimid and solid rubber.

Example of description:

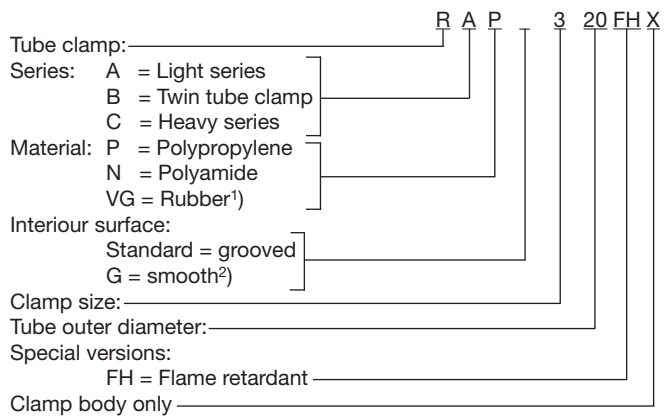

Corrosion retardant clamps

Our anti-corrosion finish is the ideal solution for areas at risk of corrosion.

Anticorrosion was developed on the basis of the approved polypropylene.

A specialised corrosion inhibitor effectively slows down the development of crevice corrosion between the clamp bodies and the tubework.

These corrosion-preventing properties were tested and recorded by salt spray tests in accordance with DIN EN ISO 9227.

Tube clamps made of PP-CR are available in the A+C series of our approved tube clamp range.

The source material is polypropylene, and the colour of the clamps is always slate grey.

Advantages:

- Enormous reduction of crevice corrosion
- Extension of maintenance intervals
- Cost reduction due to extended durability of the tubing

Example of description:

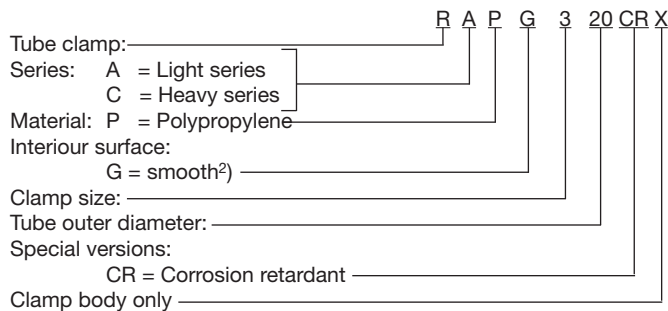

¹⁾ Rubber for series A and B only with smooth interior surface (G).

²⁾ Inside smooth series A not for size 0.

Inside smooth series C only up to size 8.

Clamps with smooth interior surface and without prestress.

Tube clamps assembly instruction

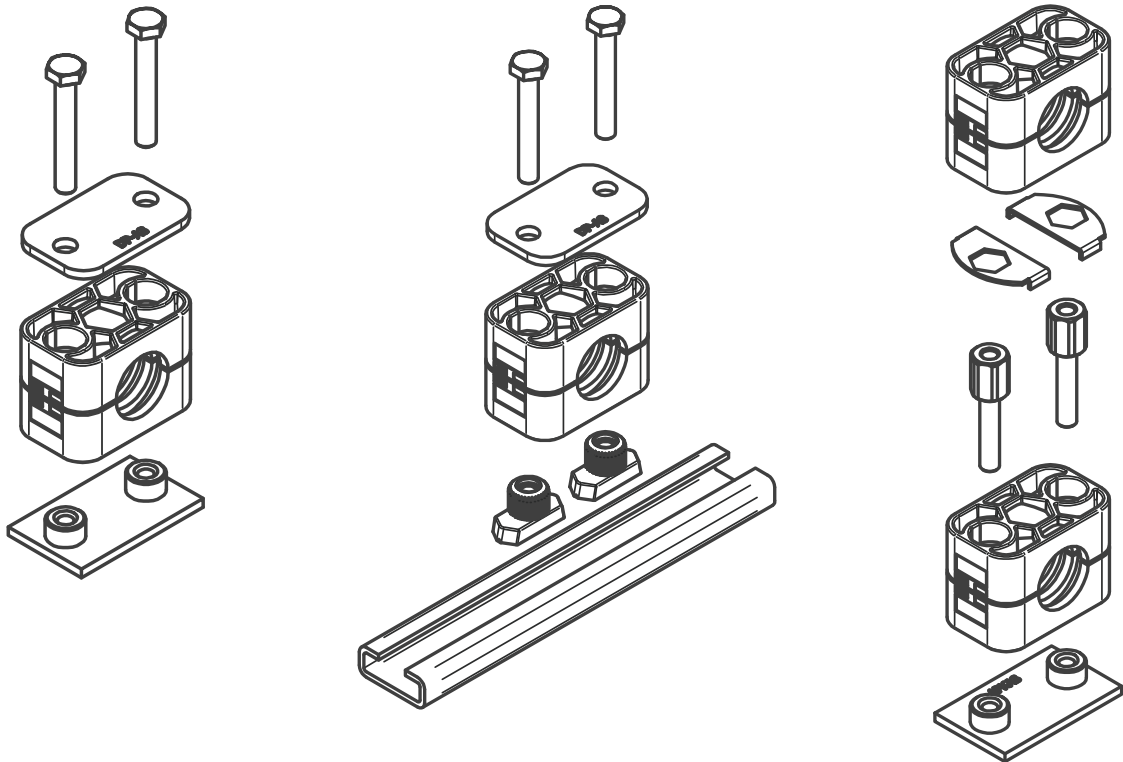

Assembly:

Assembly on to metal welding plates

Place welding plates on a base appropriate for the load. Make sure that the clamps are properly aligned. Clamp lower clamp half onto welding plate, insert tube, place upper clamp half onto lower half and fasten with the screws. Attention must be paid to the bias (after completed assembly, clamp halves may not be in contact)! Do not weld with fitted plastic clamp! Extended welding plates may be screw-fastened to the base.

Assembly on support rails

Support rails are available in four different heights and come in pieces of 1 m or 2 m length, as required. Weld on support rail or screw-fasten with fastening angle bracket. Insert support rail nuts in rail and turn until stoppage. For heavy duty construction series, nuts are simply pushed in. Clamp lower clamp half on support rail nuts, insert tube, place upper clamp half onto lower half and fasten with the screws. Before fastening the screws the clamp may still be positioned. Attention must be paid to the bias (after completed assembly, the clamp halves may not be in contact)!

Construction assembly

Clamps allow the assembly of multiple clamps of the same construction size and of different tube diameters one above the other. The construction assembly is carried out with special fixing screws that are secured against twisting by applying a locking plate. Clamp lower clamp half on welding plate or support rail respectively, insert tube, place upper clamp half on lower half and fasten with fixing screws. The fixing screw juts out from the upper clamp half. The application of a locking plate securely fastens the fixing screw and prevents twisting. Clamp on second clamp half on to the fixing screws etc.

Tube clamps

DIN 3015

Screw tightening torque and axial pipe shearing forces

The indicated screw tightening torque and axial pipe shearing forces refer to the assembly with cover plates and outside hexagon bolts according to DIN 931/933.

The axial pipe shearing force (according to DIN 3015, part 10) is an average value, determined by three tests made with a steel pipe according to DIN 2448 of St. 37, for which static friction is assumed (temperature during tests: 23°C). When loading the clamp with the indicated test force (F) in axial pipe direction, the pipe must not slide in the clamp.

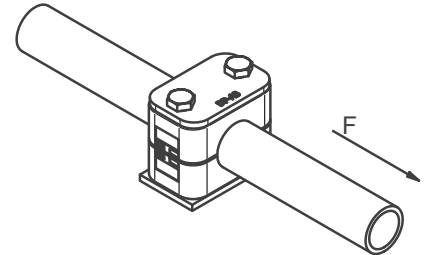

Series A - Light series (DIN 3015, part 1)

Size	Fixing screw DIN 931/933	Polypropylene		Polyamide		Aluminium	
		Screw tightening torque (Nm)	Pipe shearing force F (kN)	Screw tightening torque (Nm)	Pipe shearing force F (kN)	Screw tightening torque (Nm)	Pipe shearing force F (kN)
0	M6	8	0.6	10	0.6	–	–
1	M6	8	1.1	10	0.7	12	4.2
2	M6	8	1.2	10	0.8	12	4.3
3	M6	8	1.4	10	1.6	12	4.8
4	M6	8	1.5	10	1.7	12	5.0
5	M6	8	1.9	10	2.0	12	7.3
6	M6	8	2.0	10	2.5	12	8.9
7	M6	8	2.3	10	3.2	–	–
8	M6	8	2.6	10	3.5	–	–

Series B - Double series (DIN 3015, part 3)

Size	Fixing screw DIN 931/933	Polypropylene		Polyamide	
		Screw tightening torque (Nm,)	Pipe shearing force F (kN)	Screw tightening torque (Nm)	Pipe shearing force F (kN)
1	M6	5	0.9	6	0.9
2	M8	12	2.1	12	2.2
3	M8	12	1.9	12	2.0
4	M8	12	2.7	12	2.9
5	M8	8	1.7	8	2.5

Series C - Heavy series (DIN 3015, part 2)

Size	Fixing screw DIN 931/933	Polypropylene		Polyamide		Aluminium	
		Screw tightening torque (Nm)	Pipe shearing force F (kN)	Screw tightening torque (Nm)	Pipe shearing force F (kN)	Screw tightening torque (Nm)	Pipe shearing force F (kN)
1	M10	12	1.6	20	4.2	30	12.1
2	M10	12	2.9	20	4.5	30	15.1
3	M10	15	3.3	25	5.1	35	15.5
4	M12	30	8.2	40	9.3	55	29.4
5	M16	45	11.0	55	15.8	120	34.8
6	M20	80	14.0	150	21.0	220	50.0
7	M24	110	28.0	200	32.0	250	70.6
8	M30	180	40.0	350	48.0	500	84.5
9	M30	200	119.0	370	125.0	500	181.5
10	M30	270	168.0	450	180.0	600	244.5

For further information on clamp mouting, see page F14 following.

Tube clamps

Tube clamps series A (Light construction series) – Components

DIN 3015, part 1

Order codes for clamp halves:

Material	Interior surface	Order code
Polypropylene	grooved	RAP
	smooth	RAPG
Polyamide	grooved	RAN
	smooth	RANG
Rubber	smooth	RAVG¹⁾
Aluminium	grooved	RAA²⁾

(Please exchange as required standard abbreviation RAP in column for "clamp halves")

For flame- or corrosion retardant materials, please refer to page T5.

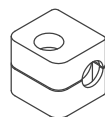

size 0

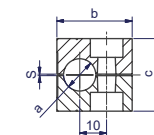

size 0

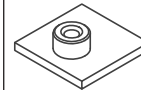

size 0

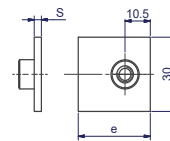

size 0

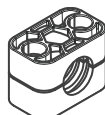

size 1-8

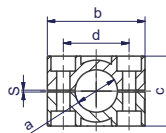

size 1-8

Width: 30 mm

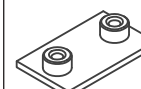

size 1-8

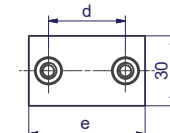

size 1-8

clamp size	Tube O.D. mm a	Tube NB	Tube O.D.	1 part 2 clamp halves		welding plate, short			
				RAP... Order code	dimensions: b c d s	APK A... Order code	dimensions: d e s		
0	4.0	G 1/8	1/4 5/16 3/8	RAP004X RAP006X RAP006.4X RAP008X RAP009.5X RAP010X RAP012X	28 27 - 0.6	APKA0...*	-	30	3
	6.0								
	6.4								
	8.0								
	9.5								
	10.0								
12.0									
1	4.0	G 1/8	1/4 5/16 3/8	RAP104X RAP106X RAP106.4X RAP108X RAP109.5X RAP110X RAP112X	34 27 20 0.6	APKA1...*	20	36	3
	6.0								
	6.4								
	8.0								
	9.5								
	10.0								
12.0									
2	12.7	G 1/4	1/2	RAP212.7X RAP213.5X RAP214X RAP215X RAP216X RAP217.2X RAP218X	42 33 26 0.8	APKA2...*	26	42	3
	13.5								
	14.0								
	15.0	G 3/8	5/8	RAP216X RAP217.2X RAP218X	42 33 26 0.8	APKA2...*	26	42	3
	16.0								
	17.2								
18.0									
3	19.0	G 1/2	3/4 1	RAP319X RAP320X RAP321.3X RAP322X RAP323X RAP325X RAP325.4X	49 35 33 1.0	APKA3...*	33	50	3
	20.0								
	21.3								
	22.0								
	23.0								
	25.0								
25.4									
4	26.9	G 3/4		RAP426.9X RAP428X RAP430X	59 42 40 1.2	APKA4...*	40	59	3
	28.0								
	30.0								
5	32.0	G 1	1 1/4	RAP532X RAP533.7X RAP535X RAP538X RAP540X RAP542X	71 58 52 1.2	APKA5...*	52	72	3
	33.7								
	35.0								
	38.0	G 1 1/4	1 1/2	RAP532X RAP533.7X RAP535X RAP538X RAP540X RAP542X	71 58 52 1.2	APKA5...*	52	72	3
	40.0								
	42.0								

Continuation see next page ...

Tube clamps series A (Light construction series) – Components (Continued)

DIN 3015, part 1

Order codes for clamp halves:

Material	Interior surface	Order code
Polypropylene	grooved	RAP
	smooth	RAPG
Polyamide	grooved	RAN
	smooth	RANG
Rubber	smooth	RAVG¹⁾
Aluminium	grooved	RAA²⁾

(Please exchange as required standard abbreviation RAP in column for "clamp halves")

For flame- or corrosion retardant materials, please refer to page T5.

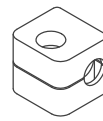

size 0

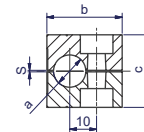

size 0

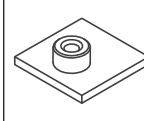

size 0

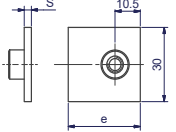

size 0

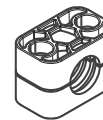

size 1-8

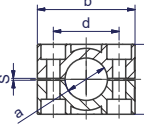

size 1-8

Width: 30 mm

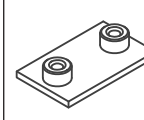

size 1-8

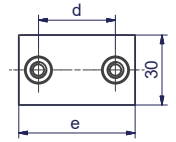

size 1-8

clamp size	Tube O.D. mm a	Tube NB	Tube O.D.	1 part 2 clamp halves		welding plate, short			
				RAP... Order code	dimensions: b c d s	APK A... Order code	dimensions: d e s		
6	44.5	G 1 1/2	1 3/4	RAP644.5X RAP645X RAP648X RAP650X RAP650.8X RAP652X RAP654X RAP655X RAP657X	86 66 66 1.2	APKA6...*	66	88	3
	45.0		2						
	48.0		2 1/4						
	50.0								
	50.8								
	52.0								
	54.0								
55.0									
57.0									
7	57.2	G 2	2 1/4	RAP757.2X RAP760.3X RAP763.5X RAP770X RAP773X RAP776.1X	121 93.6 94 1.6	APKA7...*	94	122	5
	60.3		2 1/2						
	63.5		2 3/4						
	70.0								
	73.0								
76.1	G 2 1/2	3							
8	88.9	G 3	4	RAP888.9X RAP8101.8X	147 117.6 120 1.6	APKA8...*	120	148	5
	101.8	G 3 1/2							

¹⁾ When assembling solid rubber clamps, covering plates, hexagon screws and locking washers must be used.

²⁾ Aluminium sizes 0-6

*Please add the suffix below according to the surface/material required.

Order code suffixes		
Surface/material	Suffix	Example
Steel, phosphated	X	APKA0X
Steel, zinc plated, Cr(VI)-free	VZX	APKA0VZX
Stainless Steel 1.4571	4571X	APKA04571X

Tube clamps

Tube clamps series A (Light construction series) – Components

DIN 3015, part 1

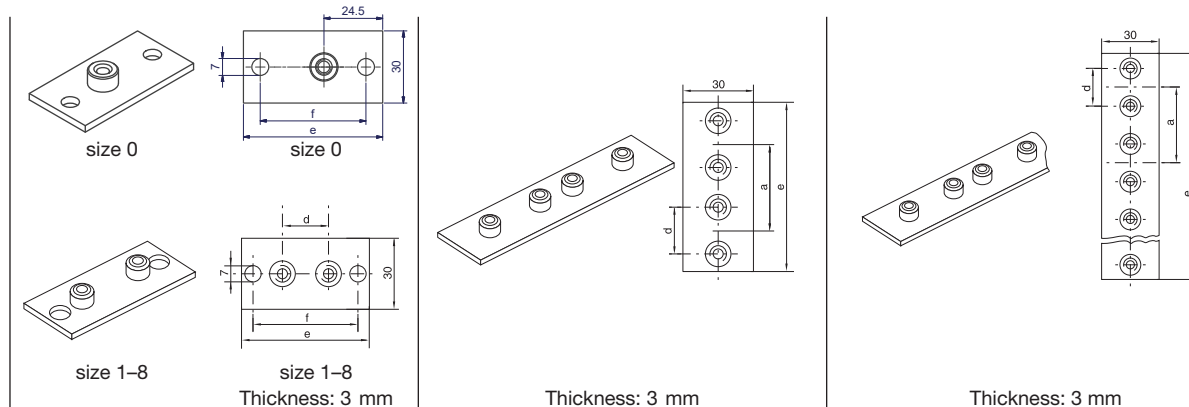

clamp size	weld/screw plate, long			twin welding plate			multiple weld plate					
	APL A... Order code	dimensions: d e f			APD A... Order code	dimensions: d a e			APR A... Order code	dimensions: d a e		
0	APLA0...*	–	58	44	APDA0...*	–	30	61	APRA0...* (10 clamps)	–	30	298
1	APLA1...*	20	64	50	APDA1...*	20	35	69	APRA1...* (10 clamps)	20	35	349
2	APLA2...*	26	70	56	APDA2...*	26	43	86	APRA2...* (10 clamps)	26	43	427
3	APLA3...*	33	78	64	APDA3...*	33	52	104	APRA3...* (10 clamps)	33	52	516
4	APLA4...*	40	87	73	APDA4...*	40	60	117	APRA4...* (5 clamps)	40	60	297
5	APLA5...*	52	100	86	APDA5...*	52	75	145	APRA5...* (5 clamps)	52	75	370
6	APLA6...*	66	116	100	APDA6...*	66	90	176	APRA6...* (5 clamps)	66	90	446
7	APLA7...*	94	150	136								
8	APLA8...*	120	178	162								

*Please add the suffix below according to the surface/material required.

Order code suffixes		
Surface/material	Suffix	Example
Steel, phosphated	X	APLA0X
Steel, zinc plated, Cr(VI)-free	VZX	APLA0VZX
Stainless Steel 1.4571	4571X	APLA04571X

Tube clamps series A (Light construction series) – Components

DIN 3015, part 1



size 0

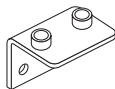

size 1-6

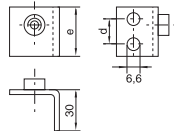

size 0

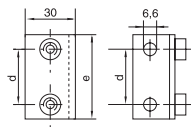

size 1-6

Thickness: 3 mm

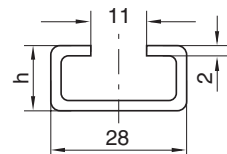
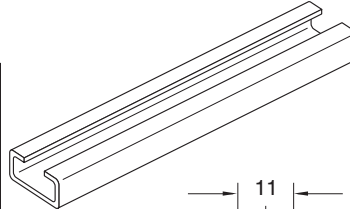

1 or 2 mtr

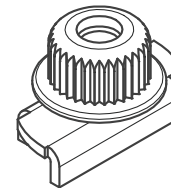
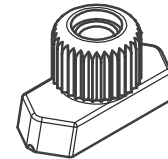
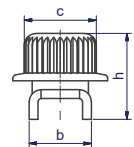
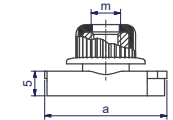
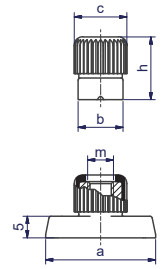
 With loss protection
(See page T54).

clamp size	weld plate, angled		mounting rail		rail nut	
	APWA A... Order code	dimensions: d e	TS...A/B Order code	dimensions: h	TM...A/B1 Order code	dimensions: a b c m h
0	APWA0X APWA04571X	14 30	TS11A/B1...* TS11A/B2...* TS14A/B1...* TS14A/B2...* TS30A/B1...* TS30A/B2...*	TS11: 11 TS14: 14 TS30: 30	TMA/TMB1VERZX TMA/TMB1/4571X	25.410.4 12 M6 14.5
1	APWA1X APWA14571X	20 36				
2	APWA2X APWA24571X	26 42				
3	APWA3X APWA34571X	33 50			TMA/TMB1WLPVZX TMA/TMB1WLP71X	24.910.5 12 M6 14.5
4	APWA4X APWA44571X	40 59				
5	APWA5X APWA54571X	52 72				
6	APWA6X APWA64571X	66 88				

*Please add the suffix below according to the surface/material required.

Order code suffixes		
Surface/material	Suffix	Example
Steel, phosphated	X	TS11A/B1X
Steel, zinc plated, Cr(VI)-free	VZX	TS11A/B1VZX
Stainless Steel 1.4571	71X	TS11A/B171X

Tube clamps series A (Light construction series) – Components

DIN 3015, part 1

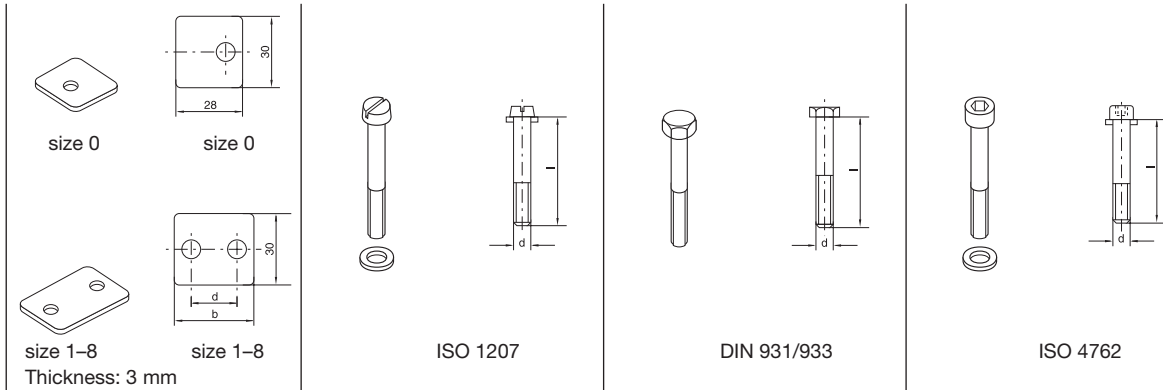

clamp size	cover plate		slot head		hexagon head		socket head	
	DP A... Order code	dimensions: b d	SL A... Order code	dimensions: d x L	SSL A... Order code	dimensions: d x L	IS A... Order code	dimensions: d x L
0	DPA0...*	– –	SLA0...*	M 06x20	SSLA0...*	M 06x30	ISA0...*	M 06x20
1	DPA1...*	34 20	SLA0...*	M 06x20	SSLA0...*	M 06x30	ISA0...*	M 06x20
2	DPA2...*	40 26	SLA2...*	M 06x25	SSLA2/SSB1...*	M 06x35	ISA2...*	M 06x25
3	DPA3...*	48 33	SLA3...*	M 06x30	SSLA3...*	M 06x40	ISA3...*	M 06x30
4	DPA4...*	57 40	SLA4...*	M 06x35	SSLA4...*	M 06x45	ISA4...*	M 06x35
5	DPA5...*	70 52	SLA5...*	M 06x50	SSLA5...*	M 06x60	ISA5...*	M 06x50
6	DPA6...*	86 66	SLA6...*	M 06x60	SSLA6...*	M 06x70	ISA6...*	M 06x60
7	DPA7...*	120 94	SLA7...*	M 06x90	SSLA7...*	M 06x100	ISA7...*	M 06x90
8	DPA8...*	146 120	SLA8...*	M 06x110	SSLA8...*	M 06x125	ISA8...*	M 06x110

*Please add the suffix below according to the surface/material required.

Order code suffixes		
Surface/material	Suffix	Example
Steel, zinc plated, Cr(VI)-free	X	DPA0X
Stainless Steel 1.4571	4571X	DPA04571X

Tube clamps series A (Light construction series) – Components

DIN 3015, part 1

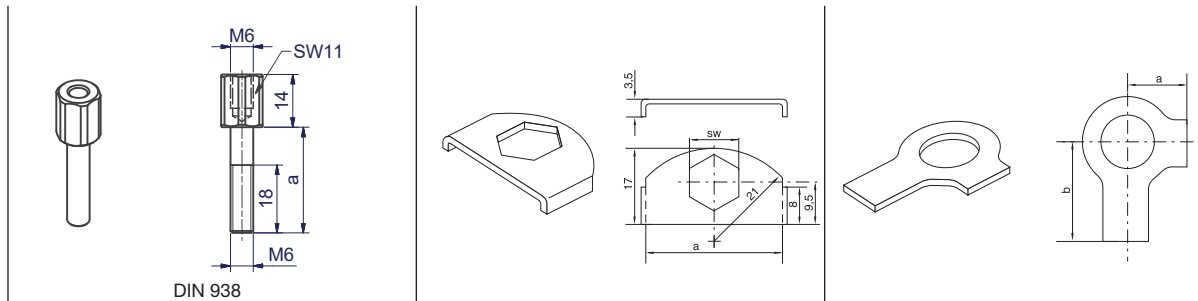

clamp size	stacking ¹⁾		locking plate ¹⁾		locking washer ²⁾	
	AS A... Order code	dimensions: a	SB A Order code	dimensions: a SW	US A Order code	dimensions: a b
0	ASA0...* (ASB1...*)	20	SBA...*	30 11	USA/USB1X ³⁾	9 18
1	ASA0...* (ASB1...*)	20				
2	ASA2...*	25				
3	ASA3...*	28				
4	ASA4...*	34				
5	ASA5...*	50				
6	ASA6...*	60				
7	ASA7...*	85				
8	ASA8...*	110				

¹⁾ The use of stacking bolts necessitates the use of locking plates in the construction assembly.

²⁾ When assembling solid rubber clamps, cover plates, hexagon screws and locking washers must be used.

³⁾ Material = stainless steel 1.4571

*Please add the suffix below according to the surface/material required.

Order code suffixes		
Surface/material	Suffix	Example
Steel, zinc plated, Cr(VI)-free	X	DPA0X
Stainless Steel 1.4571	4571X	DPA04571X

Tube clamps

Tube clamps series A (Light construction series) – Complete range
Order codes for clamp halves:

Material	Interior surface	Order code
Polypropylene	grooved	RAP
	smooth	RAPG
Polyamide	grooved	RAN
	smooth	RANG
Rubber	smooth	RAVG ¹⁾
Aluminium	grooved	RAA ²⁾

(Please exchange as required standard abbreviation RAP in column for "Order code")

For flame- or corrosion retardant materials, please refer to page T5.

The steel parts of kits 1, 2 and 3 have the following surfaces:

Screws, bushes, cover plates = Cr(VI)-free galvanized

Welding plate = phosphated

Other compositions available on request.

2 clamp halves, weld plate **short**, slot head bolts and bushes

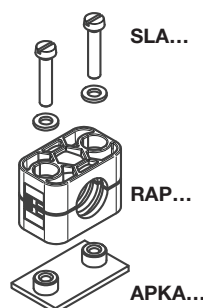

2 clamp halves, weld plate **short**, socket head bolts and bushes

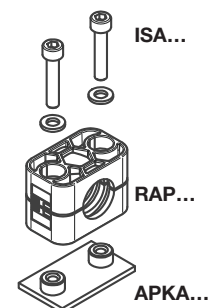

2 clamp halves, weld plate **short**, cover plate hex. head bolts

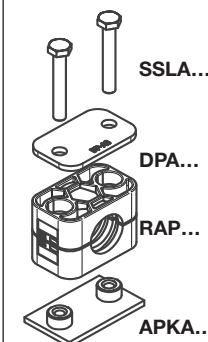

clamp size	Tube O.D. mm	Tube NB	Tube O.D.	Order code	Order code	Order code
0 ³⁾	4.0	G 1/8	1/4	RAP1-004	RAP2-004	RAP3-004
	6.0			RAP1-006	RAP2-006	RAP3-006
	6.4			RAP1-006.4	RAP2-006.4	RAP3-006.4
	8.0			RAP1-008	RAP2-008	RAP3-008
	9.5			RAP1-009.5	RAP2-009.5	RAP3-009.5
	10.0			RAP1-010	RAP2-010	RAP3-010
1	12.0	G 1/8	3/8	RAP1-012	RAP2-012	RAP3-012
	4.0			RAP1-104	RAP2-104	RAP3-104
	6.0			RAP1-106	RAP2-106	RAP3-106
	6.4			RAP1-106.4	RAP2-106.4	RAP3-106.4
	8.0			RAP1-108	RAP2-108	RAP3-108
	9.5			RAP1-109.5	RAP2-109.5	RAP3-109.5
2	10.0	G 3/8	5/8	RAP1-110	RAP2-110	RAP3-110
	12.0			RAP1-112	RAP2-112	RAP3-112
	12.7			RAP1-212.7	RAP2-212.7	RAP3-212.7
	13.5			RAP1-213.5	RAP2-213.5	RAP3-213.5
	14.0			RAP1-214	RAP2-214	RAP3-214
	15.0			RAP1-215	RAP2-215	RAP3-215
3	16.0	G 1/2	1	RAP1-216	RAP2-216	RAP3-216
	17.2			RAP1-217.2	RAP2-217.2	RAP3-217.2
	18.0			RAP1-218	RAP2-218	RAP3-218
	19.0			RAP1-319	RAP2-319	RAP3-319
	20.0			RAP1-320	RAP2-320	RAP3-320
	21.3			RAP1-321.3	RAP2-321.3	RAP3-321.3
4	22.0	G 3/4	1	RAP1-322	RAP2-322	RAP3-322
	23.0			RAP1-323	RAP2-323	RAP3-323
	25.0			RAP1-325	RAP2-325	RAP3-325
	25.4			RAP1-325.4	RAP2-325.4	RAP3-325.4
	26.9			RAP1-426.9	RAP2-426.9	RAP3-426.9
	28.0			RAP1-428	RAP2-428	RAP3-428
5	30.0	G 1	1 1/4	RAP1-430	RAP2-430	RAP3-430
	32.0			RAP1-532	RAP2-532	RAP3-532
	33.7			RAP1-533.7	RAP2-533.7	RAP3-533.7
	35.0			RAP1-535	RAP2-535	RAP3-535
	38.0			RAP1-538	RAP2-538	RAP3-538
	40.0			RAP1-540	RAP2-540	RAP3-540
6	42.0	G 1 1/4	2	RAP1-542	RAP2-542	RAP3-542
	44.5			RAP1-644.5	RAP2-644.5	RAP3-644.5
	45.0			RAP1-645	RAP2-645	RAP3-645
	48.0			RAP1-648	RAP2-648	RAP3-648
	50.0			RAP1-650	RAP2-650	RAP3-650
	50.8			RAP1-650.8	RAP2-650.8	RAP3-650.8
6	52.0	G 1 1/2	2	RAP1-652	RAP2-652	RAP3-652
	54.0			RAP1-654	RAP2-654	RAP3-654
	55.0			RAP1-655	RAP2-655	RAP3-655
	57.0			RAP1-657	RAP2-657	RAP3-657

Continuation see next page ...

Tube clamps series A (Light construction series) – Complete range

Order codes for clamp halves:

Material	Interior surface	Order code
Polypropylene	grooved	RAP
	smooth	RAPG
Polyamide	grooved	RAN
	smooth	RANG
Rubber	smooth	RAVG¹⁾
Aluminium	grooved	RAA²⁾

(Please exchange as required standard abbreviation RAP in column for "Order code")

For flame- or corrosion retardant materials, please refer to page T5.

The steel parts of kits 1, 2 and 3 have the following surfaces:

Screws, bushes, cover plates = Cr(VI)-free galvanized

Welding plate = phosphated

Other compositions available on request.

2 clamp halves, weld plate **short**, slot head bolts and bushes

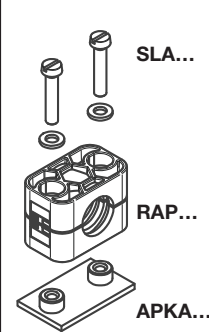

2 clamp halves, weld plate **short**, socket head bolts and bushes

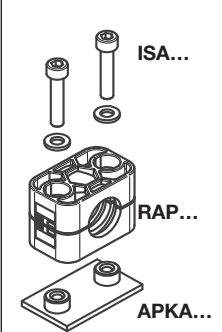

2 clamp halves, weld plate **short**, cover plate hex. head bolts

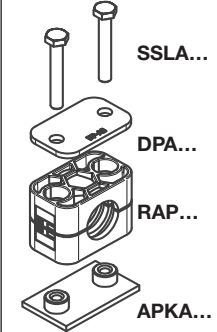

clamp size	Tube O.D. mm	Tube NB	Tube O.D.	Order code	Order code	Order code
7	57.2	G 2	2 1/4	RAP1-757.2	RAP2-757.2	RAP3-757.2
	60.3		2 1/2	RAP1-760.3	RAP2-760.3	RAP3-760.3
	63.5		2 3/4	RAP1-763.5	RAP2-763.5	RAP3-763.5
	70.0	G 2 1/2	3	RAP1-770	RAP2-770	RAP3-770
	73.0			RAP1-773	RAP2-773	RAP3-773
	76.1			RAP1-776.1	RAP2-776.1	RAP3-776.1
8	88.9	G 3	4	RAP1-888.9	RAP2-888.9	RAP3-888.9
	101.8			RAP1-8101.8	RAP2-8101.8	RAP3-8101.8

Delivery in unassembled individual components.

¹⁾ When assembling solid rubber clamps, cover plates, hexagon screws and locking washers must be used.

²⁾ Aluminium size 0-6.

³⁾ Contrary to the illustration size 0 clamps are secured by only one screw.

Tube clamps series A (Light construction series) – Complete range

Order codes for clamp halves:

Material	Interior surface	Order code
Polypropylene	grooved	RAP
	smooth	RAPG
Polyamide	grooved	RAN
	smooth	RANG
Rubber	smooth	RAVG¹⁾
Aluminium	grooved	RAA²⁾

(Please exchange as required standard abbreviation RAP in column for "Order code")

For flame- or corrosion retardant materials, please refer to page T5.

The steel parts of kits 4, 5 and 6 have the following surfaces:

Screws, bushes, cover plates = Cr(VI)-free galvanized

Welding plate = phosphated

Other compositions available on request.

2 clamp halves, weld/
screw plate, slot head
bolts and bushes

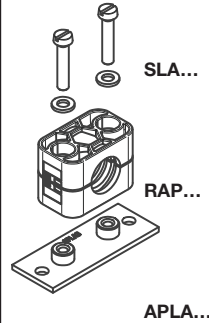

2 clamp halves, weld/
screw plate, socket
head bolts and bushes

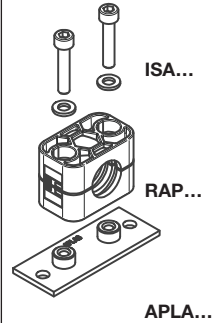

2 clamp halves, weld/
screw plate, cover
plate and hex. head
bolts

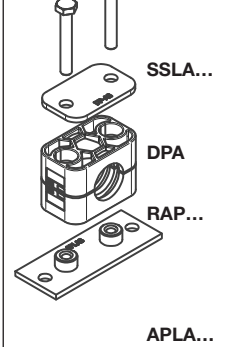

clamp size	Tube O.D. mm	Tube NB	Tube O.D.	Order code	Order code	Order code		
0 ³⁾	4.0	G 1/8	1/4	RAP4-004	RAP5-004	RAP6-004		
	6.0			RAP4-006	RAP5-006	RAP6-006		
	6.4			RAP4-006.4	RAP5-006.4	RAP6-006.4		
	8.0			RAP4-008	RAP5-008	RAP6-008		
	9.5			RAP4-009.5	RAP5-009.5	RAP6-009.5		
	10.0			RAP4-010	RAP5-010	RAP6-010		
1	12.0	G 1/8	3/8	RAP4-012	RAP5-012	RAP6-012		
	4.0			RAP4-104	RAP5-104	RAP6-104		
	6.0			RAP4-106	RAP5-106	RAP6-106		
	6.4			RAP4-106.4	RAP5-106.4	RAP6-106.4		
	8.0			RAP4-108	RAP5-108	RAP6-108		
	9.5			RAP4-109.5	RAP5-109.5	RAP6-109.5		
2	10.0	G 3/8	5/8	RAP4-110	RAP5-110	RAP6-110		
	12.0			RAP4-112	RAP5-112	RAP6-112		
	12.7			G 1/4	1/2	RAP4-212.7	RAP5-212.7	RAP6-212.7
	13.5					RAP4-213.5	RAP5-213.5	RAP6-213.5
	14.0					RAP4-214	RAP5-214	RAP6-214
	15.0					RAP4-215	RAP5-215	RAP6-215
16.0	RAP4-216	RAP5-216	RAP6-216					
17.2	RAP4-217.2	RAP5-217.2	RAP6-217.2					
3	18.0	G 1/2	3/4	RAP4-218	RAP5-218	RAP6-218		
	19.0			RAP4-319	RAP5-319	RAP6-319		
	20.0			RAP4-320	RAP5-320	RAP6-320		
	21.3			RAP4-321.3	RAP5-321.3	RAP6-321.3		
	22.0			RAP4-322	RAP5-322	RAP6-322		
	23.0			RAP4-323	RAP5-323	RAP6-323		
4	25.0	G 3/4	1	RAP4-325	RAP5-325	RAP6-325		
	25.4			RAP4-325.4	RAP5-325.4	RAP6-325.4		
	26.9			RAP4-426.9	RAP5-426.9	RAP6-426.9		
	28.0			RAP4-428	RAP5-428	RAP6-428		
5	30.0	G 1	1 1/4	RAP4-430	RAP5-430	RAP6-430		
	32.0			RAP4-532	RAP5-532	RAP6-532		
	33.7			RAP4-533.7	RAP5-533.7	RAP6-533.7		
	35.0			RAP4-535	RAP5-535	RAP6-535		
	38.0			RAP4-538	RAP5-538	RAP6-538		
	40.0			RAP4-540	RAP5-540	RAP6-540		
6	42.0	G 1 1/4	1 1/2	RAP4-542	RAP5-542	RAP6-542		
	44.5			RAP4-644.5	RAP5-644.5	RAP6-644.5		
	45.0	G 1 1/2	2	RAP4-645	RAP5-645	RAP6-645		
	48.0			RAP4-648	RAP5-648	RAP6-648		
	50.0			RAP4-650	RAP5-650	RAP6-650		
	50.8			RAP4-650.8	RAP5-650.8	RAP6-650.8		
	52.0			RAP4-652	RAP5-652	RAP6-652		
	54.0			RAP4-654	RAP5-654	RAP6-654		
	55.0			RAP4-655	RAP5-655	RAP6-655		
	57.0			RAP4-657	RAP5-657	RAP6-657		

Continuation see next page ...

Tube clamps series A (Light construction series) – Complete range

Order codes for clamp halves:

Material	Interior surface	Order code
Polypropylene	grooved	RAP
	smooth	RAPG
Polyamide	grooved	RAN
	smooth	RANG
Rubber	smooth	RAVG¹⁾
Aluminium	grooved	RAA²⁾

(Please exchange as required standard abbreviation RAP in column for "Order code")

For flame- or corrosion retardant materials, please refer to page T5.

The steel parts of kits 4, 5 and 6 have the following surfaces:

Screws, bushes, cover plates = Cr(VI)-free galvanized

Welding plate = phosphated

Other compositions available on request.

2 clamp halves, weld/
screw plate, slot head
bolts and bushes

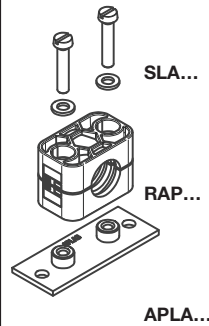

2 clamp halves, weld/
screw plate, socket
head bolts and bushes

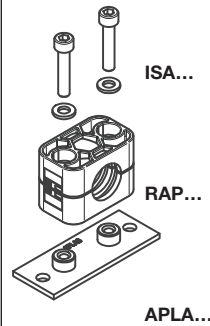

2 clamp halves, weld/
screw plate, cover
plate and hex. head
bolts

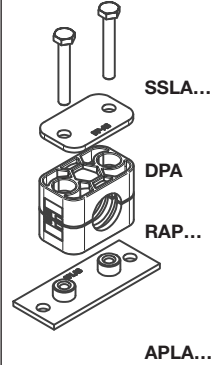

clamp size	Tube O.D. mm	Tube NB	Tube O.D.	Order code	Order code	Order code
7	57.2	G 2	2 1/4	RAP4-757.2	RAP5-757.2	RAP6-757.2
	60.3		2 1/2	RAP4-760.3	RAP5-760.3	RAP6-760.3
	63.5		2 3/4	RAP4-763.5	RAP5-763.5	RAP6-763.5
	70.0	G 2 1/2	3	RAP4-770	RAP5-770	RAP6-770
	73.0			RAP4-773	RAP5-773	RAP6-773
	76.1			RAP4-776.1	RAP5-776.1	RAP6-776.1
8	88.9	G 3	3 1/2	RAP4-888.9	RAP5-888.9	RAP6-888.9
	101.8		4	RAP4-8101.8	RAP5-8101.8	RAP6-8101.8

Delivery in unassembled individual components.

¹⁾ When assembling solid rubber clamps, cover plates, hexagon screws and locking washers must be used.

²⁾ Aluminium size 0-6.

³⁾ Contrary to the illustration size 0 clamps are secured by only one screw.

Tube clamps series A (Light construction series) – Complete range

Order codes for clamp halves:

Material	Interior surface	Order code
Polypropylene	grooved	RAP
	smooth	RAPG
Polyamide	grooved	RAN
	smooth	RANG
Rubber	smooth	RAVG¹⁾
Aluminium	grooved	RAA²⁾

(Please exchange as required standard abbreviation RAP in column for "Order code")

For flame- or corrosion retardant materials, please refer to page T5.

The steel parts of kits 9, 10 and 12 have the following surfaces:

Screws, bushes, cover plates = Cr(VI)-free galvanized

Welding plate = phosphated

Other compositions available on request.

2 clamp halves, rail nuts, slot head bolts and bushes

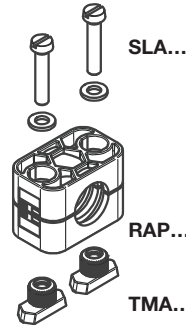

2 clamp halves, rail nuts, socket head bolts and bushes

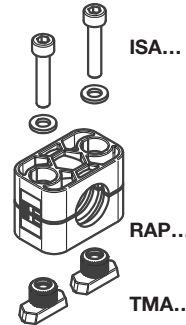

2 clamp halves, rail nuts, cover plate and hex. head bolts

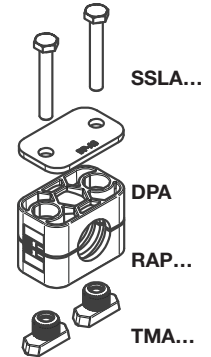

clamp size	Tube O.D. mm	Tube NB	Tube O.D.	Order code	Order code	Order code
0 ³⁾	4.0	G 1/8	1/4 5/16 3/8	RAP9-004	RAP10-004	RAP12-004
	6.0			RAP9-006	RAP10-006	RAP12-006
	6.4			RAP9-006.4	RAP10-006.4	RAP12-006.4
	8.0			RAP9-008	RAP10-008	RAP12-008
	9.5			RAP9-009.5	RAP10-009.5	RAP12-009.5
	10.0			RAP9-010	RAP10-010	RAP12-010
1	12.0	G 1/8	1/4 5/16 3/8	RAP9-012	RAP10-012	RAP12-012
	4.0			RAP9-104	RAP10-104	RAP12-104
	6.0			RAP9-106	RAP10-106	RAP12-106
	6.4			RAP9-106.4	RAP10-106.4	RAP12-106.4
	8.0			RAP9-108	RAP10-108	RAP12-108
	9.5			RAP9-109.5	RAP10-109.5	RAP12-109.5
2	10.0	G 3/8	1/2 5/8	RAP9-110	RAP10-110	RAP12-110
	12.0			RAP9-112	RAP10-112	RAP12-112
	12.7			RAP9-212.7	RAP10-212.7	RAP12-212.7
	13.5			RAP9-213.5	RAP10-213.5	RAP12-213.5
	14.0			RAP9-214	RAP10-214	RAP12-214
	15.0			RAP9-215	RAP10-215	RAP12-215
3	16.0	G 1/2	3/4 1	RAP9-216	RAP10-216	RAP12-216
	17.2			RAP9-217.2	RAP10-217.2	RAP12-217.2
	18.0			RAP9-218	RAP10-218	RAP12-218
	19.0			RAP9-319	RAP10-319	RAP12-319
	20.0			RAP9-320	RAP10-320	RAP12-320
	21.3			RAP9-321.3	RAP10-321.3	RAP12-321.3
4	22.0	G 3/4	1 1/4	RAP9-322	RAP10-322	RAP12-322
	23.0			RAP9-323	RAP10-323	RAP12-323
	25.0			RAP9-325	RAP10-325	RAP12-325
	25.4			RAP9-325.4	RAP10-325.4	RAP12-325.4
5	26.9	G 1	1 1/2	RAP9-426.9	RAP10-426.9	RAP12-426.9
	28.0			RAP9-428	RAP10-428	RAP12-428
	30.0			RAP9-430	RAP10-430	RAP12-430
	32.0			RAP9-532	RAP10-532	RAP12-532
6	33.7	G 1 1/4	2	RAP9-533.7	RAP10-533.7	RAP12-533.7
	35.0			RAP9-535	RAP10-535	RAP12-535
	38.0			RAP9-538	RAP10-538	RAP12-538
	40.0			RAP9-540	RAP10-540	RAP12-540
	42.0	RAP9-542	RAP10-542	RAP12-542		
	44.5	G 1 1/2	2	RAP9-644.5	RAP10-644.5	RAP12-644.5
	45.0			RAP9-645	RAP10-645	RAP12-645
	48.0			RAP9-648	RAP10-648	RAP12-648
50.0	RAP9-650			RAP10-650	RAP12-650	
50.8	RAP9-650.8	RAP10-650.8	RAP12-650.8			
52.0	RAP9-652	RAP10-652	RAP12-652			
54.0	RAP9-654	RAP10-654	RAP12-654			
55.0	RAP9-655	RAP10-655	RAP12-655			
57.0	RAP9-657	RAP10-657	RAP12-657			

Continuation see next page ...

Tube clamps series A (Light construction series) – Complete range

Order codes for clamp halves:

Material	Interior surface	Order code
Polypropylene	grooved	RAP
	smooth	RAPG
Polyamide	grooved	RAN
	smooth	RANG
Rubber	smooth	RAVG¹⁾
Aluminium	grooved	RAA²⁾

(Please exchange as required standard abbreviation RAP in column for "Order code")

For flame- or corrosion retardant materials, please refer to page T5.

The steel parts of kits 9, 10 and 12 have the following surfaces:

Screws, bushes, cover plates = Cr(VI)-free galvanized

Welding plate = phosphated

Other compositions available on request.

2 clamp halves, rail nuts, slot head bolts and bushes

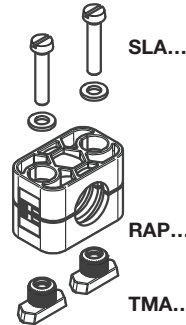

2 clamp halves, rail nuts, socket head bolts and bushes

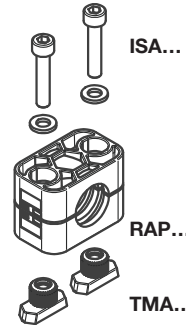

2 clamp halves, rail nuts, cover plate and hex. head bolts

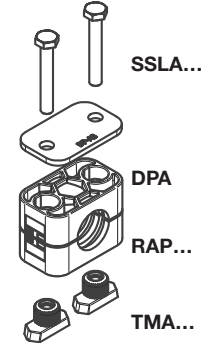

clamp size	Tube O.D. mm	Tube NB	Tube O.D.	Order code	Order code	Order code
7	57.2	G 2	2 1/4	RAP9-757.2	RAP10-757.2	RAP12-757.2
	60.3		2 1/2	RAP9-760.3	RAP10-760.3	RAP12-760.3
	63.5		2 3/4	RAP9-763.5	RAP10-763.5	RAP12-763.5
	70.0			RAP9-770	RAP10-770	RAP12-770
	73.0	G 2 1/2	3	RAP9-773	RAP10-773	RAP12-773
	76.1		RAP9-776.1	RAP10-776.1	RAP12-776.1	
8	88.9	G 3	3 1/2	RAP9-888.9	RAP10-888.9	RAP12-888.9
	101.8		4	RAP9-8101.8	RAP10-8101.8	RAP12-8101.8

Delivery in unassembled individual components.

¹⁾ When assembling solid rubber clamps, cover plates, hexagon screws and locking washers must be used.

²⁾ Aluminium size 0-6.

³⁾ Contrary to the illustration size 0 clamps are secured by only one screw.

Tube clamps

Tube clamps series A – Complete range

Order codes for clamp halves:

Material	Interior surface	Order code
Polypropylene	grooved	RAP
	smooth	RAPG
Polyamide	grooved	RAN
	smooth	RANG
Rubber	smooth	RAVG¹⁾
Aluminium	grooved	RAA²⁾

(Please exchange as required standard abbreviation RAP in column for "Order code")

For flame- or corrosion retardant materials, please refer to page T5.

The steel parts of kits 13 and 14 have the following surfaces:

Screws, bushes, cover plates = Cr(VI)-free galvanized

Welding plate = phosphated

Other compositions available on request.

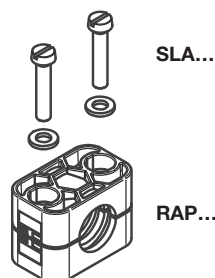
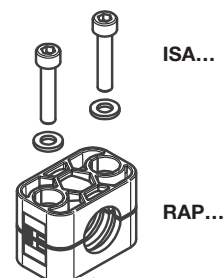
 2 clamp halves, slot
heads and bushes

 2 clamp halves, slot
head bolts and
bushes

clamp size	Tube O.D. mm	Tube NB	Tube O.D.	Order code	Order code
0 ³⁾	4.0	G 1/8	1/4	RAP13-004	RAP14-004
	6.0			RAP13-006	RAP14-006
	6.4			RAP13-006.4	RAP14-006.4
	8.0			RAP13-008	RAP14-008
	9.5			RAP13-009.5	RAP14-009.5
	10.0			RAP13-010	RAP14-010
1	12.0	G 1/8	3/8	RAP13-012	RAP14-012
	4.0			RAP13-104	RAP14-104
	6.0			RAP13-106	RAP14-106
	6.4			RAP13-106.4	RAP14-106.4
	8.0			RAP13-108	RAP14-108
	9.5			RAP13-109.5	RAP14-109.5
2	10.0	G 3/8	5/8	RAP13-110	RAP14-110
	12.0			RAP13-112	RAP14-112
	12.7			RAP13-212.7	RAP14-212.7
	13.5			RAP13-213.5	RAP14-213.5
	14.0			RAP13-214	RAP14-214
	15.0			RAP13-215	RAP14-215
3	16.0	G 1/2	3/4	RAP13-216	RAP14-216
	17.2			RAP13-217.2	RAP14-217.2
	18.0			RAP13-218	RAP14-218
	19.0			RAP13-319	RAP14-319
	20.0			RAP13-320	RAP14-320
	21.3			RAP13-321.3	RAP14-321.3
4	22.0	G 3/4	1	RAP13-322	RAP14-322
	23.0			RAP13-323	RAP14-323
	25.0			RAP13-325	RAP14-325
	25.4			RAP13-325.4	RAP14-325.4
	26.9			RAP13-426.9	RAP14-426.9
	28.0			RAP13-428	RAP14-428
5	30.0	G 1	1 1/4	RAP13-430	RAP14-430
	32.0			RAP13-532	RAP14-532
	33.7			RAP13-533.7	RAP14-533.7
	35.0			RAP13-535	RAP14-535
	38.0			RAP13-538	RAP14-538
	40.0			RAP13-540	RAP14-540
6	42.0	G 1 1/4	2	RAP13-542	RAP14-542
	44.5			RAP13-644.5	RAP14-644.5
	45.0			RAP13-645	RAP14-645
	48.0			RAP13-648	RAP14-648
	50.0			RAP13-650	RAP14-650
	50.8			RAP13-650.8	RAP14-650.8
	52.0			RAP13-652	RAP14-652
	54.0			RAP13-654	RAP14-654
55.0	RAP13-655	RAP14-655			
57.0	RAP13-657	RAP14-657			

Continuation see next page ...

Tube clamps series A – Complete range

Order codes for clamp halves:

Material	Interior surface	Order code
Polypropylene	grooved	RAP
	smooth	RAPG
Polyamide	grooved	RAN
	smooth	RANG
Rubber	smooth	RAVG¹⁾
Aluminium	grooved	RAA²⁾

(Please exchange as required standard abbreviation RAP in column for "Order code")

For flame- or corrosion retardant materials, please refer to page T5.

The steel parts of kits 13 and 14 have the following surfaces:

Screws, bushes, cover plates = Cr(VI)-free galvanized

Welding plate = phosphated

Other compositions available on request.

2 clamp halves, slot heads and bushes

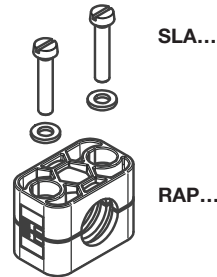

2 clamp halves, socket head bolts and bushes

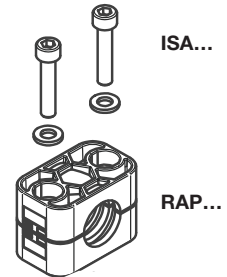

clamp size	Tube O.D. mm	Tube NB	Tube O.D.	Order code	Order code
7	57.2	G 2	2 1/4	RAP13-757.2	RAP14-757.2
	60.3		2 1/2	RAP13-760.3	RAP14-760.3
	63.5		2 3/4	RAP13-763.5	RAP14-763.5
	70.0	G 2 1/2	3	RAP13-770	RAP14-770
	73.0		RAP13-773	RAP14-773	
76.1			RAP13-776.1	RAP14-776.1	
8	88.9	G3	3 1/2	RAP13-888.9	RAP14-888.9
	101.8		4	RAP13-8101.8	RAP14-8101.8

Delivery in unassembled individual components.

¹⁾ When assembling solid rubber clamps, cover plates, hexagon screws and locking washers must be used.

²⁾ Aluminium size 0-6.

³⁾ Contrary to the illustration size 0 clamps are secured by only one screw.

Tube clamps

Tube clamps series A – Complete range

Order codes for clamp halves:

Material	Interior surface	Order code
Polypropylene	grooved	RAP
	smooth	RAPG
Polyamide	grooved	RAN
	smooth	RANG
Rubber	smooth	RAVG ¹⁾
Aluminium	grooved	RAA ²⁾

(Please exchange as required standard abbreviation RAP in column for "Order code")

For flame- or corrosion retardant materials, please refer to page T5.

The steel parts of kits 16 and 18 have the following surfaces:

Screws, bushes, cover plates = Cr(VI)-free galvanized

Welding plate = phosphated

Other compositions available on request.

2 clamp halves, cover plate and hex. head bolts

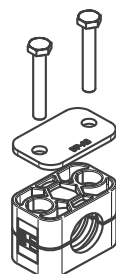

SSLA...

DPA...

RAP...

2 clamp halves, stacking bolts and locking plate

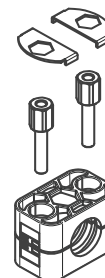

SBA...

ASA...

RAP...

clamp size	Tube O.D. mm	Tube NB	Tube O.D.	Order code	Order code
0 ³⁾	4.0	G 1/8	1/4	RAP16-004	RAP18-004
	6.0			RAP16-006	RAP18-006
	6.4			RAP16-006.4	RAP18-006.4
	8.0			RAP16-008	RAP18-008
	9.5			RAP16-009.5	RAP18-009.5
	10.0			RAP16-010	RAP18-010
1	12.0	G 1/8	3/8	RAP16-012	RAP18-012
	4.0			RAP16-104	RAP18-104
	6.0			RAP16-106	RAP18-106
	6.4			RAP16-106.4	RAP18-106.4
	8.0			RAP16-108	RAP18-108
	9.5			RAP16-109.5	RAP18-109.5
2	10.0	G 3/8	5/8	RAP16-110	RAP18-110
	12.0			RAP16-112	RAP18-112
	12.7			RAP16-212.7	RAP18-212.7
	13.5			RAP16-213.5	RAP18-213.5
	14.0			RAP16-214	RAP18-214
	15.0			RAP16-215	RAP18-215
3	16.0	G 1/2	1	RAP16-216	RAP18-216
	17.2			RAP16-217.2	RAP18-217.2
	18.0			RAP16-218	RAP18-218
	19.0			RAP16-319	RAP18-319
	20.0			RAP16-320	RAP18-320
	21.3			RAP16-321.3	RAP18-321.3
4	22.0	G 3/4	1 1/4	RAP16-322	RAP18-322
	23.0			RAP16-323	RAP18-323
	25.0			RAP16-325	RAP18-325
	25.4			RAP16-325.4	RAP18-325.4
	26.9			RAP16-426.9	RAP18-426.9
	28.0			RAP16-428	RAP18-428
5	30.0	G 1	1 1/2	RAP16-430	RAP18-430
	32.0			RAP16-532	RAP18-532
	33.7			RAP16-533.7	RAP18-533.7
	35.0			RAP16-535	RAP18-535
	38.0			RAP16-538	RAP18-538
	40.0			RAP16-540	RAP18-540
6	42.0	G 1 1/4	2	RAP16-542	RAP18-542
	44.5			RAP16-644.5	RAP18-644.5
	45.0			RAP16-645	RAP18-645
	48.0			RAP16-648	RAP18-648
	50.0			RAP16-650	RAP18-650
	50.8			RAP16-650.8	RAP18-650.8
	52.0	G 1 1/2	2	RAP16-652	RAP18-652
	54.0			RAP16-654	RAP18-654
	55.0			RAP16-655	RAP18-655
	57.0			RAP16-657	RAP18-657

Continuation see next page ...

Tube clamps series A – Complete range

Order codes for clamp halves:

Material	Interior surface	Order code
Polypropylene	grooved	RAP
	smooth	RAPG
Polyamide	grooved	RAN
	smooth	RANG
Rubber	smooth	RAVG¹⁾
Aluminium	grooved	RAA²⁾

(Please exchange as required standard abbreviation RAP in column for "Order code")

For flame- or corrosion retardant materials, please refer to page T5.

The steel parts of kits 16 and 18 have the following surfaces:

Screws, bushes, cover plates = Cr(VI)-free galvanized

Welding plate = phosphated

Other compositions available on request.

2 clamp halves, cover plate and hex. head bolts



SSLA

DPA...

RAP...

2 clamp halves, stacking bolts and locking plate

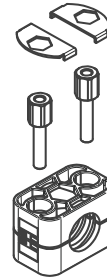

SBA...

ASA...

RAP...

clamp size	Tube O.D. mm	Tube NB	Tube O.D.	Order code	Order code
7	57.2	G 2	2 1/4	RAP16-757.2	RAP18-757.2
	60.3		2 1/2	RAP16-760.3	RAP18-760.3
	63.5		2 3/4	RAP16-763.5	RAP18-763.5
	70.0		RAP16-770	RAP18-770	
	73.0	G 2 1/2	3	RAP16-773	RAP18-773
	76.1		RAP16-776.1	RAP18-776.1	
8	88.9	G 3	3 1/2	RAP16-888.9	RAP18-888.9
	101.8		4	RAP16-8101.8	RAP18-8101.8

Delivery in unassembled individual components.

¹⁾ When assembling solid rubber clamps, cover plates, hexagon screws and locking washers must be used.

²⁾ Aluminium sizes 0-6.

³⁾ Contrary to the illustration size 0 clamps are secured by only one screw.

Tube clamps

Tube clamps series B (Twin-tube clamps) – Components

DIN 3015, part 3

Order codes for clamp halves:

Material	Interior surface	Order code
Polypropylene	grooved	RBP
	smooth	RBPG
Polyamide	grooved	RBN
	smooth	RBNG
Rubber	smooth	RBVG¹⁾

(Please exchange as required standard abbreviation RBP in column for "clamp halves")

For flame- or corrosion retardant materials, please refer to page T5.

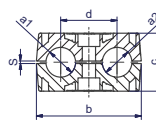
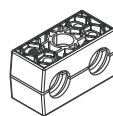

Width: 30 mm

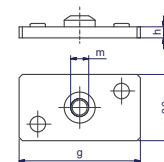
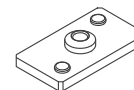

clamp size	Tube O.D. mm	Tube NB	Tube O.D.	1 part 2 clamp halves ²⁾		weld plate with locking device			
				RBP... Order code	dimensions: b c d s	APB... Order code	dimensions: g m h		
1	6.0	G 1/8	1/4 5/16 3/8	RBP106X RBP106.4X RBP108X RBP109.5X RBP110X RBP112X	36 27.0 20 1.0	APB1...*	37	M6	3
	6.4								
	8.0								
	9.5								
	10.0								
	12.0								
2	12.7	G 1/4 G 3/8	1/2 5/8	RBP212.7X RBP213.5X RBP214X RBP215X RBP216X RBP217.2X RBP218X	53 27.4 29 1.2	APB2...*	55	M8	5
	13.5								
	14.0								
	15.0								
	16.0								
	17.2								
3	19.0	G 1/2	3/4 1	RBP319X RBP320X RBP321.3X RBP322X RBP325X RBP325.4X	67 37.0 36 1.6	APB3...*	70	M8	5
	20.0								
	21.3								
	22.0								
	25.0								
	25.4								
4	26.9	G 3/4		RBP426.9X RBP428X RBP430X	82 42.0 45 2.0	APB4...*	85	M8	5
	28.0								
	30.0								
5	32.0	G 1 G 1 1/4	1 1/4 1 1/2	RBP532X RBP533.7X RBP535X RBP538X RBP540X RBP542X	106 54.0 56 2.0	APB5...*	110	M8	5
	33.7								
	35.0								
	38.0								
	40.0								
	42.0								

¹⁾ When assembling solid rubber clamps, cover plates, hexagon screws and locking washers must be used.

²⁾ Twin-tube clamps with different outer tube diameters upon request.

*Please add the suffix below according to the surface/material required.

Order code suffixes		
Surface/material	Suffix	Example
Steel, phosphated	X	APB1X
Steel, zinc plated, Cr(VI)-free	VZX	APB1VZX
Stainless Steel 1.4571	4571X	APB14571X

Tube clamps series B (Twin-tube clamps) – Components

DIN 3015, part 3

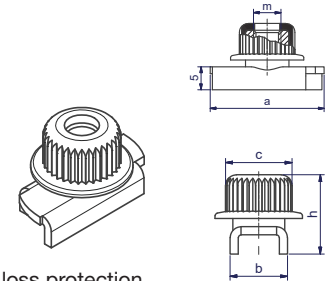
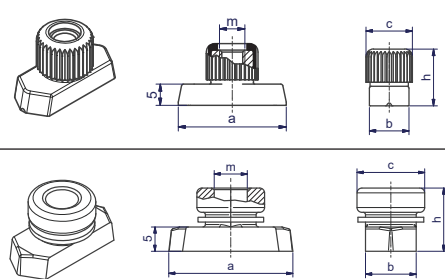
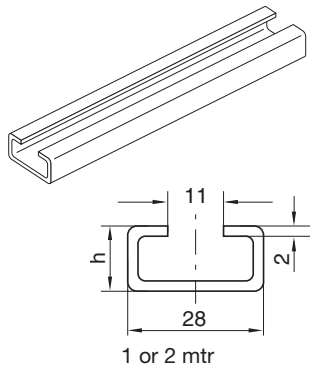
 With loss protection
(See page T54).

clamp size	weld plate, angled		mounting rail nut						mounting rail nut					
	TS...A/B Order code	dimensions: h	TM Order code	dimensions: a b c m h					TMA/TMB1... Order code	dimensions: a b c m h				
1			TMA/TMB1VERZX TMA/TMB1/4571X	25.4	10.4	12	M6	14.5	TMA/TMB1WLPVZX TMA/TMB1WLP71X	25.4	10.4	12	M6	14.5
2	TS11A/B1...* TS11A/B2...* TS14A/B1...* TS14B/B2...* TS30A/B1...* TS30B/B2...*	TS11: TS14: TS30:	TMB2VZX TMB24571X	25.4	10.4	14	M8	13.0						
3														
4														
5														

*Please add the suffix below according to the surface/material required.

Order code suffixes		
Surface/material	Suffix	Example
Steel, phosphated	X	TS11A/B1X
Steel, zinc plated, Cr(VI)-free	VZX	TS11A/B1VZX
Stainless Steel 1.4571	71X	TS11A/B171X

Tube clamps series B (Twin-tube clamps) – Components

DIN 3015, part 3

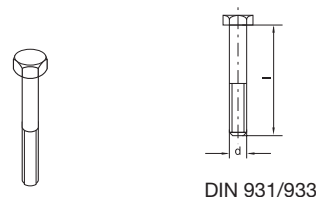
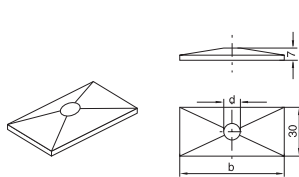
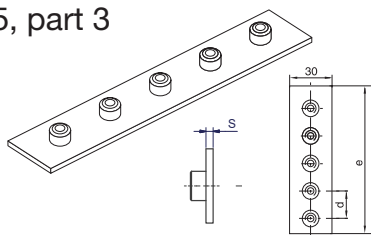

clamp size	weld plate angled (5 clamps)			cover plate			hexagonal screws		
	APR B... Order code	dimensions: d e		s	DP B... Order code	dimensions: b d		SS B... Order code	dimensions: d x L
1	APRB1X APRB1VZX APRB4571X	40	196	3	DPB1...*	34	6.6	SSLA2/SSB1...*	M 06x35
2	APRB2X APRB2VZX APRB24571X	58	288	5	DPB2...*	51	8.6	SSB2...*	M 08x35
3	APRB3X APRB3VZX APRB34571X	72	358	5	DPB3...*	64	8.6	SSB3...*	M 08x45
4	APRB4X APRB4VZX APRB44571X	90	446	5	DPB4...*	78	8.6	SSB4...*	M 08x50
5	APRB5X APRBVZX APRB4571X	112	558	5	DPB5...*	102	8.6	SSB5...*	M 08x60

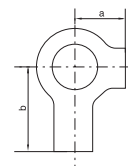
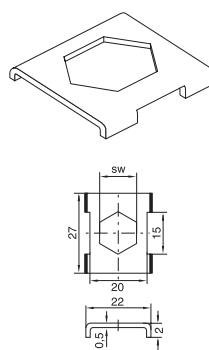
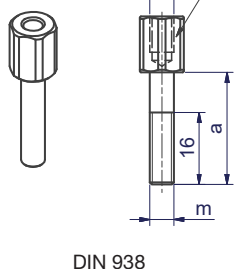
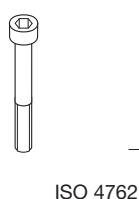

clamp size	socket head		stacking			locking plate ¹⁾		locking washer ²⁾	
	IS B... Order code	dimensions: d x L	AS B... Order code	dimensions: a m SW		SB B... Order code	dim.: SW	US... Order code	dimensions: a b
1	ISA4...* (ISB1...*)	M 06x35	ASA0...* (ASB1...*)	20	M6 11	SBB1...*	11	USA/USB1X ³⁾	9 18
2	ISB2...*	M 08x35	ASB2...*	22	M8 12	SBB2...*	12	USB2X USB271X	11 20
3	ISB3...*	M 08x45	ASB3...*	30	M8 12				
4	ISB4...*	M 08x50	ASB4...*	35	M8 12				
5	ISB5...*	M 08x60	ASB5...*	47	M8 12				

1) The use of stacking screws necessitates the use of locking plates in the construction assembly!

2) When assembling solid rubber clamps, covering plates, hexagon screws and locking washers must be used.

3) Material = Stainless steel 1.4571

*Please add the suffix below according to the surface/material required.

Order code suffixes		
Surface/material	Suffix	Example
Steel, zinc plated, Cr(VI)-free	X	DPB1X
Stainless Steel 1.4571	71X	DPB14571X

Tube clamps series B – Complete range

Order codes for clamp halves:

Material	Interior surface	Order code
Polypropylene	grooved	RBP
	smooth	RBPG
Polyamide	grooved	RBN
	smooth	RBNG
Rubber	smooth	RBVG¹⁾

(Please exchange as required standard abbreviation RBP in column for "Order code")

For flame- or corrosion retardant materials, please refer to page T5.

The steel parts of kits 1, 16 and 3 have the following surfaces:

Screws, bushes, cover plates = Cr(VI)-free galvanized

Welding plate = phosphated

Other compositions available on request.

2 clamp halves, weld plate, cover plate, hex. head bolt

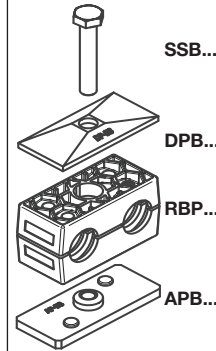

2 clamp halves, cover plate, hex. head bolt

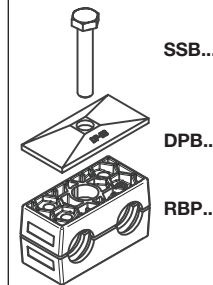

2 clamp halves, weld plate, cover plate, socket head bolt

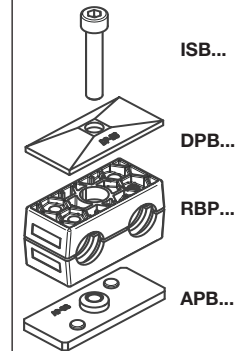

clamp size	Tube O.D. mm	Tube NB	Tube O.D.	Order code	Order code	Order code
1	6.0	G 1/8	1/4 5/16 3/8	RBP1-106	RBP16-106	RBP3-106
	6.4			RBP1-106.4	RBP16-106.4	RBP3-106.4
	8.0			RBP1-108	RBP16-108	RBP3-108
	9.5			RBP1-109.5	RBP16-109.5	RBP3-109.5
	10.0			RBP1-110	RBP16-110	RBP3-110
	12.0			RBP1-112	RBP16-112	RBP3-112
2	12.7	G 1/4 G 3/8	1/2 5/8	RBP1-212.7	RBP16-212.7	RBP3-212.7
	13.5			RBP1-213.5	RBP16-213.5	RBP3-213.5
	14.0			RBP1-214	RBP16-214	RBP3-214
	15.0			RBP1-215	RBP16-215	RBP3-215
	16.0			RBP1-216	RBP16-216	RBP3-216
	17.2			RBP1-217.2	RBP16-217.2	RBP3-217.2
18.0	RBP1-218	RBP16-218	RBP3-218			
3	19.0	G 1/2	3/4 1	RBP1-319	RBP16-319	RBP3-319
	20.0			RBP1-320	RBP16-320	RBP3-320
	21.3			RBP1-321.3	RBP16-321.3	RBP3-321.3
	22.0			RBP1-322	RBP16-322	RBP3-322
	25.0			RBP1-325	RBP16-325	RBP3-325
	25.4			RBP1-325.4	RBP16-325.4	RBP3-325.4
4	26.9	G 3/4		RBP1-426.9	RBP16-426.9	RBP3-426.9
	28.0			RBP1-428	RBP16-428	RBP3-428
	30.0			RBP1-430	RBP16-430	RBP3-430
5	32.0	G 1 G 1 1/4	1 1/4 1 1/2	RBP1-532	RBP16-532	RBP3-532
	33.7			RBP1-533.7	RBP16-533.7	RBP3-533.7
	35.0			RBP1-535	RBP16-535	RBP3-535
	38.0			RBP1-538	RBP16-538	RBP3-538
	40.0			RBP1-540	RBP16-540	RBP3-540
	42.0			RBP1-542	RBP16-542	RBP3-542

Delivery in unassembled individual components.

¹⁾ When assembling solid rubber clamps, covering plates, hexagon screws and locking washers must be used.

Tube clamps series B – Complete range

Order codes for clamp halves:

Material	Interior surface	Order code
Polypropylene	grooved	RBP
	smooth	RBPG
Polyamide	grooved	RBN
	smooth	RBNG
Rubber	smooth	RBVG ¹⁾

(Please exchange as required standard abbreviation RBP in column for "Order code")

For flame- or corrosion retardant materials, please refer to page T5.

The steel parts of kits 4, 5 and 8 have the following surfaces:

Screws, bushes, cover plates = Cr(VI)-free galvanized

Welding plate = phosphated

Other compositions available on request.

2 clamp halves,
rail nut, cover plate,
hex. head bolt

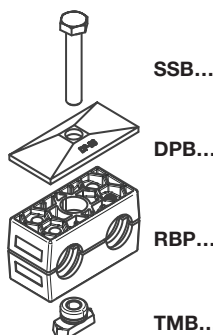

2 clamp halves,
rail nut, cover plate,
socket head bolt

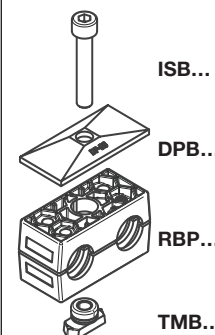

2 clamp halves,
locking plate,
stacking bolt

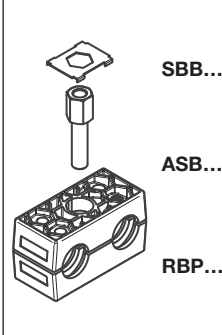

clamp size	Tube O.D. mm	Tube NB	Tube O.D.	Order code	Order code	Order code
1	6.0	G 1/8	1/4 5/16 3/8	RBP4-106	RBP5-106	RBP8-106
	6.4			RBP4-106.4	RBP5-106.4	RBP8-106.4
	8.0			RBP4-108	RBP5-108	RBP8-108
	9.5			RBP4-109.5	RBP5-109.5	RBP8-109.5
	10.0			RBP4-110	RBP5-110	RBP8-110
	12.0			RBP4-112	RBP5-112	RBP8-112
2	12.7	G 1/4 G 3/8	1/2 5/8	RBP4-212.7	RBP5-212.7	RBP8-212.7
	13.5			RBP4-213.5	RBP5-213.5	RBP8-213.5
	14.0			RBP4-214	RBP5-214	RBP8-214
	15.0			RBP4-215	RBP5-215	RBP8-215
	16.0			RBP4-216	RBP5-216	RBP8-216
	17.2			RBP4-217.2	RBP5-217.2	RBP8-217.2
18.0	RBP4-218	RBP5-218	RBP8-218			
3	19.0	G 1/2	3/4 1	RBP4-319	RBP5-319	RBP8-319
	20.0			RBP4-320	RBP5-320	RBP8-320
	21.3			RBP4-321.3	RBP5-321.3	RBP8-321.3
	22.0			RBP4-322	RBP5-322	RBP8-322
	25.0			RBP4-325	RBP5-325	RBP8-325
	25.4			RBP4-325.4	RBP5-325.4	RBP8-325.4
4	26.9	G 3/4		RBP4-426.9	RBP5-426.9	RBP8-426.9
	28.0			RBP4-428	RBP5-428	RBP8-428
	30.0			RBP4-430	RBP5-430	RBP8-430
5	32.0	G 1 G 1 1/4	1 1/4 1 1/2	RBP4-532	RBP5-532	RBP8-532
	33.7			RBP4-533.7	RBP5-533.7	RBP8-533.7
	35.0			RBP4-535	RBP5-535	RBP8-535
	38.0			RBP4-538	RBP5-538	RBP8-538
	40.0			RBP4-540	RBP5-540	RBP8-540
	42.0			RBP4-542	RBP5-542	RBP8-542

Delivery in unassembled individual components.

1) When assembling solid rubber clamps, covering plates, hexagon screws and locking washers must be used.

Tube clamps series C (Heavy series) – Components

DIN 3015, part 2

Order codes for clamp halves:

Material	Interior surface	Order code
Polypropylene	grooved	RCP
	smooth	RCPG ¹⁾
Polyamide	grooved	RCN
	smooth	RCNG ¹⁾
Rubber	grooved	RCVR ¹⁾²⁾
	smooth	RCVG ¹⁾²⁾
Aluminium	grooved	RCA

(Please exchange as required standard abbreviation RCP in column for “clamp halves”)

For flame- or corrosion retardant materials, please refer to page T5.

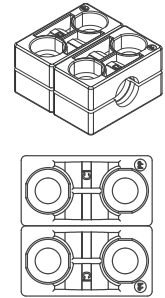
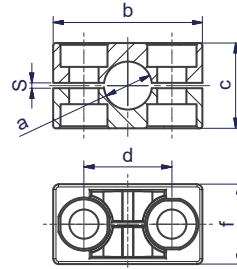
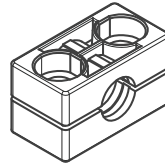

Please order 2x the single clamp (e.g. 2x RCP...)

clamp size	Tube O.D. mm a	Tube NB	Tube O.D.	1 part 2 clamp halves					dimensions: f	
				RCP... Order code	dimensions:					
				b	c	d	s	f		
1	6.0	G 1/8	5/16	RCP106X	56	32	33	2	30	60
	8.0			RCP108X						
	9.5		RCP109.5X							
	10.0		RCP110X							
	12.0		RCP112X							
	12.7	G 1/4	1/2	RCP112.7X						
	13.5			RCP113.5X						
	14.0			RCP114X						
	15.0	G 3/8	5/8	RCP115X						
	16.0			RCP116X						
17.2	RCP117.2X									
18.0	RCP118X									
2	19.0	G 1/2	3/4	RCP219X	71	48	45	2	30	60
	20.0			RCP220X						
	21.3		RCP221.3X							
	22.0		RCP222X							
	23.0		RCP223X							
	25.0	G 3/4	1	RCP225X						
	25.4			RCP225.4X						
	26.9			RCP226.9X						
	28.0	RCP228X								
	30.0	RCP230X								
3	30.0	G 1	1 1/4	RCP330X	86	60	60	2	30	60
	32.0			RCP332X						
	33.7		RCP333.7X							
	35.0	G 1 1/4	1 1/2	RCP335X						
	38.0			RCP338X						
	40.0			RCP340X						
42.0	RCP342X									
4	38.0	G 1 1/4	1 1/2	RCP438X	117	90	90	3	45	90
	40.0			RCP440X						
	42.0			RCP442X						
	45.0	G 1 1/2	2	RCP445X						
	48.3			RCP448.3X						
	50.0			RCP450X						
	51.0	G 2	2	RCP451X						
	52.0			RCP452X						
	55.0			RCP455X						
	57.0			RCP457X						
	60.3			RCP460.3X						
	63.0	2 1/4	2 1/2	RCP463X						
	65.0			RCP465X						
70.0	RCP470X									

Continuation see next page ...

Tube clamps

Tube clamps series C (Heavy series) – Components (Continued)

DIN 3015, part 2

Order codes for clamp halves:

Material	Interior surface	Order code
Polypropylene	grooved	RCP
	smooth	RCPG ¹⁾
Polyamide	grooved	RCN
	smooth	RCNG ¹⁾
Rubber	grooved	RCVR ¹⁾²⁾
	smooth	RCVG ¹⁾²⁾
Aluminium	grooved	RCA

(Please exchange as required standard abbreviation RCP in column for “clamp halves”)

For flame- or corrosion retardant materials, please refer to page T5.

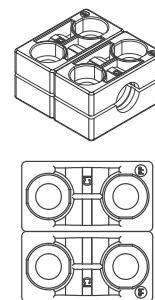
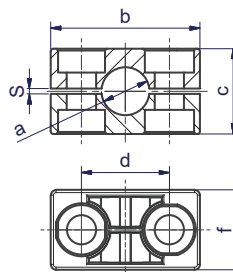
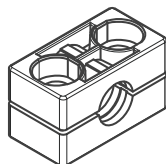

Please order 2x the single clamp (e.g. 2x RCP...)

clamp size	Tube O.D. mm a	Tube NB	Tube O.D.	1 part 2 clamp halves dimensions:					dimensions: f	
				RCP... Order code	b	c	d	s		f
5	65.0	G 2 1/2	2 3/4	RCP565X	154	120	122	5	60	120
	70.0			RCP570X						
	73.0			RCP573X						
	75.0			RCP575X						
	76.1			RCP576.1X						
	80.0	RCP580X								
	82.5	RCP582.5X								
	85.0	RCP585X								
	88.0	RCP588X								
	88.9	RCP588.9X								
90.0	RCP590X	G 3	3 1/2	RCP690X						
90.0	RCP697X									
97.0	RCP6100X									
100.0	RCP6101.6X									
101.6	RCP6108X									
108.0	RCP6114.3X									
114.3	RCP6115X									
115.0	RCP6120X									
120.0	RCP6127X									
127.0	RCP7127X	G 5	5	RCP7130X	251	200	205	6	90	180
130.0	RCP7133X									
133.0	RCP7140X									
140.0	RCP7150X									
150.0	RCP7152.4X									
152.4	RCP7159X									
159.0	RCP7165.1X									
165.1	RCP7168.3X									
168.3	RCP8168.3X									
177.8	RCP8177.8X									
190.0	RCP8190X	G 6	6 5/8	RCP8193.7X	320	270	265	6	120	240
193.7	RCP8203X									
203.0	RCP8219.1X									
203.0	RCP8220X									
219.1	RCP9219.1X									
219.1	RCP9244.5X									
220.0	RCP9273X									
220.0	RCP9323.9X									
220.0	RCP10355.6X									
220.0	RCP10406.4X									
8	168.3	G 6	6 5/8	RCP8168.3X	320	270	265	6	120	240
	177.8			RCP8177.8X						
	190.0			RCP8190X						
	193.7			RCP8193.7X						
7	150.0	G 5 1/2	6	RCP7150X	251	200	205	6	90	180
	152.4			RCP7152.4X						
	159.0			RCP7159X						
	165.1			RCP7165.1X						
6	108.0	G 4	4 1/2	RCP6108X	206	168	168	6	80	160
	114.3			RCP6114.3X						
	115.0			RCP6115X						
	120.0			RCP6120X						
9	219.1	G 8	8 5/8	RCP9219.1X	470	410	395	20	162	324
	244.5			RCP9244.5X						
	273.0			RCP9273X						
	323.9			RCP9323.9X						
10	355.6	G 14	14	RCP10355.6X	630	530	534	20	182	364
	406.4			RCP10406.4X						

1) Only sizes 1–8

2) When assembling solid rubber clamps, covering plates, hexagon screws and locking washers must be used.

Tube clamps series C (Heavy series) – Components

DIN 3015, part 2

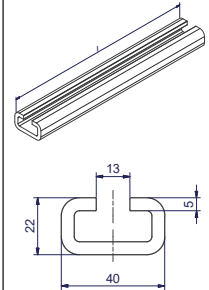
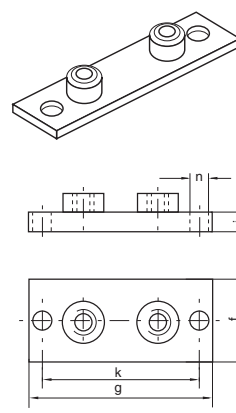
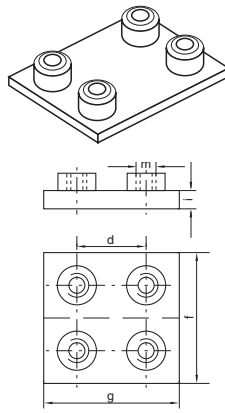
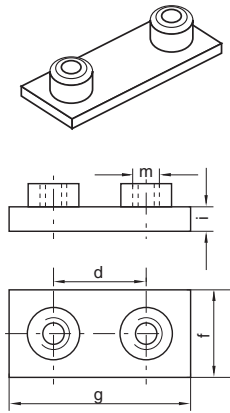

clamp size	weld plate					double weld plate					weld/screw plate					mounting rail				
	AP C... Order code	dimensions:				APD C... Order code	dimensions:				APL C... Order code	dimensions:				TS C... Order code	length: l			
		d	f	g	i	m		d	f	g	i	m		g	f	i	k	n		
1	APC1...*	33	30	73	8	M10	APDC1...*	33	60	73	8	M10	APLC1...*	113	30	8	85	11	TSC1X TSC1VERZX TSC14571X	1 m
2	APC2...*	45	30	84	8	M10	APDC2...*	45	60	84	8	M10	APLC2...*	125	30	8	97	11		
3	APC3...*	60	30	100	8	M10	APDC3...*	60	60	100	8	M10	APLC3...*	140	30	8	112	11	TSC2X TSC2VERZX TSC24571X	2m
4	APC4...*	90	45	140	10	M12	APDC4...*	90	90	140	10	M12	APLC4...*	190	45	10	160	14		
5	APC5...*	122	60	180	10	M16	APDC5...*	122	120	180	10	M16	APLC5...*	240	60	10	205	18		
6	APC6...*	168	80	225	15	M20	APDC6...*	168	160	225	15	M20	APLC6...*	310	80	15	270	22		
7	APC7...*	205	90	270	15	M24	APDC7...*	205	180	270	15	M24	APLC7...*	370	90	15	320	26		
8	APC8...*	265	120	340	25	M30	APDC8...*	265	240	340	25	M30	APLC8...*	450	120	25	390	33		
9	APC9...*	395	160	520	30	M30	APDC9...*	395	330	520	30	M30								
10	APC10...*	534	180	680	30	M30	APDC10...*	534	364	680	30	M30								

Complete programme range please refer to page T34.

*Please add the suffix below according to the surface/material required.

Order code suffixes		
Surface/material	Suffix	Example
Steel, phosphated	X	APC1X
Steel, zinc plated, Cr(VI)-free	VZX	APC1VZX
Stainless Steel 1.4571	4571X	APC14571X

Tube clamps series C (Heavy series) – Components

DIN 3015, part 2

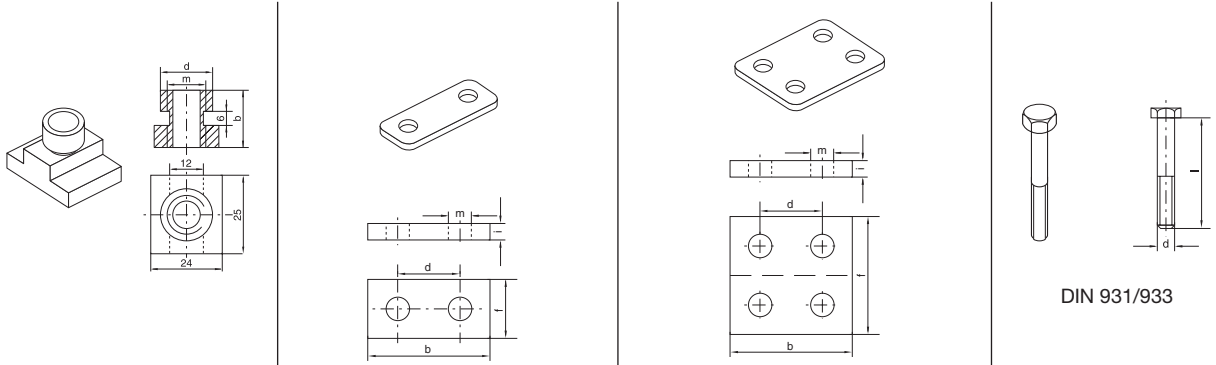

clamp size	rail nut			cover plate					double cover plate					hexagon head				
	TM C... Order code	dimensions:			DP C... Order code	dimensions:					DPD C... Order code	dimensions:					SS C... Order code	dimensions:
		b	d	m		b	d	f	i	m		b	d	f	i	m		d × L
1	TMC1VZX TMC14571X	20	12.0	M10	DPC1...*	55	33	30	8	11	DPDC1...*	55	33	60	8	11	SSC1...*	M 10×40
2					DPC2...*	70	45	30	8	11	DPDC2...*	70	45	60	8	11	SSC2...*	M 10×60
3					DPC3...*	85	60	30	8	11	DPDC3...*	85	60	60	8	11	SSC3...*	M 10×70
4	TMC4VZX TMC44571X	23	12.5	M12	DPC4...*	115	90	45	10	14	DPDC4...*	115	90	90	10	14	SSC4...*	M 12×100
5	-	-	-	-	DPC5...*	152	122	60	10	18	DPDC5...*	152	122	120	10	18	SSC5...*	M 16×130
6					DPC6...*	205	168	80	15	22	DPDC6...*	205	168	160	15	24	SSC6...*	M 20×190
7					DPC7...*	251	205	90	15	28	DPDC7...*	250	205	180	15	28	SSC7...*	M 24×220
8					DPC8...*	320	265	120	25	35	DPDC8...*	322	265	240	25	35	SSC8...*	M 30×300
9					DPC9...*	470	395	160	30	35	DPDC9...*	466	395	330	30	35	SSC9...*	M 30×450
10					DPC10...*	630	534	180	30	35	DPDC10...*	630	534	360	30	35	SSC10...*	M 30×560

*Please add the suffix below according to the surface/material required.

Order code suffixes		
Surface/material	Suffix	Example
Steel, phosphated	X	DPC1X
Steel, zinc plated, Cr(VI)-free	VZX	DPC1VZX
Stainless Steel 1.4571	4571X	DPC14571X

Tube clamps series C (Heavy series) – Components

DIN 3015, part 2

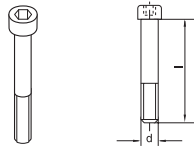

ISO 4762

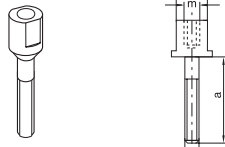

DIN 938

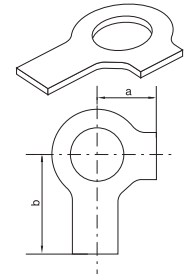
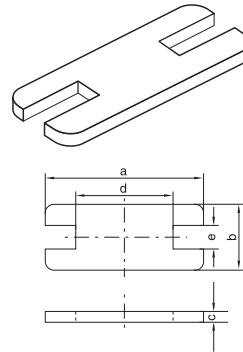

clamp size	socket head		stacking			locking plate ¹⁾					locking washer ²⁾				
	IS C... Order code	dimensions: d x L	AS C... Order code	dimensions: a m SW			SP C... Order code	dimensions: a b c d e					US C... Order code	dimensions: a b	
1	ISC1...*	M 10x45	ASC1...*	25	M10	15	SPC1...*	55	30	8	14	15.5	USC1X ³⁾ USC14571X	13	22
2	ISC2...*	M 10x60	ASC2...*	40	M10	15	SPC2...*	70	30	8	26	15.5			
3	ISC3...*	M 10x70	ASC3...*	50	M10	15	SPC3...*	85	30	8	41	15.5			
4	ISC4...*	M 12x100	ASC4...*	80	M12	17	SPC4...*	115	45	10	69	17.5	USC4X ³⁾ USC44571X	15	28
5	ISC5...*	M 16x130	ASC5...*	110	M16	21	SPC5...*	152	60	10	97	21.5	USC5X ³⁾ USC54571X	18	32
6	ISC6...*	M 20x190	ASC6...*	155	M20	27	SPC6...*	205	80	15	137	27.5	USC6X ³⁾ USC64571X	21	36
7	ISC7...*	M 24x220	ASC7...*	180	M24	30	SPC7...*	250	90	15	169	30.5	USC7X ³⁾ USC74571X	25	42
8	ISC8...*	M 30x300	ASC8...*	250	M30	36	SPC8...*	320	120	25	219	36.5	USC8X ³⁾ USC84571X	32	52
9	ISC9...*	M 30x450													
10	ISC10...*	M 30x560													

¹⁾ The use of stacking screws necessitates the use of locking plates in the construction assembly!

²⁾ When assembling solid rubber clamps, covering plates, hexagon screws and locking washers must be used.

³⁾ Material = Steel, zinc plated, Cr(VI)-free

*Please add the suffix below according to the surface/material required.

Order code suffixes		
Surface/material	Suffix	Example
Steel, phosphated	X	ISC1X
Steel, zinc plated, Cr(VI)-free	VZX	ISC1VZX
Stainless Steel 1.4571	4571X	ISC14571X

Tube clamps series C – Complete range

Order codes for clamp halves:

Material	Interior surface	Order code
Polypropylene	grooved	RCP
	smooth	RCPG ¹⁾
Polyamide	grooved	RCN
	smooth	RCNG ¹⁾
Rubber	grooved	RCVR ¹⁾²⁾
	smooth	RCVG ¹⁾²⁾
Aluminium	grooved	RCA

(Please exchange as required standard abbreviation RCP in column for "Order code")

For flame- or corrosion retardant materials, please refer to page T5.

The steel parts of kits 1 and 2 are phosphated.

Other compositions available on request.

2 clamp halves, weld plate, cover plate, hex. head bolt

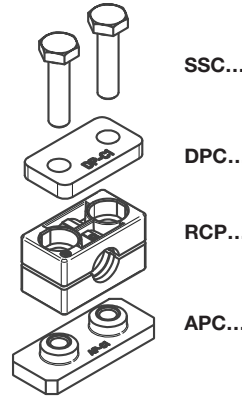

2 clamp halves, weld plate, cover plate, socket head bolt

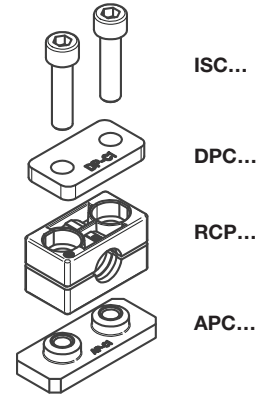

clamp size	Tube O.D. mm	Tube NB	Tube O.D.	Order code	Order code
1	6.0	G 1/8	5/16	RCP1-106	RCP2-106
	8.0		3/8	RCP1-108	RCP2-108
	9.5		RCP1-109.5	RCP2-109.5	
	10.0		RCP1-110	RCP2-110	
	12.0	G 1/4	1/2	RCP1-112	RCP2-112
	12.7		RCP1-112.7	RCP2-112.7	
	13.5		RCP1-113.5	RCP2-113.5	
	14.0	G 3/8	5/8	RCP1-114	RCP2-114
	15.0			RCP1-115	RCP2-115
	16.0			RCP1-116	RCP2-116
17.2	RCP1-117.2			RCP2-117.2	
18.0	RCP1-118			RCP2-118	
2	19.0	G 1/2	3/4	RCP1-219	RCP2-219
	20.0		RCP1-220	RCP2-220	
	21.3		RCP1-221.3	RCP2-221.3	
	22.0		RCP1-222	RCP2-222	
	23.0		RCP1-223	RCP2-223	
	25.0	G 3/4	1	RCP1-225	RCP2-225
	25.4			RCP1-225.4	RCP2-225.4
	26.9			RCP1-226.9	RCP2-226.9
	28.0			RCP1-228	RCP2-228
	30.0			RCP1-230	RCP2-230
3	30.0	G 1	1 1/4	RCP1-330	RCP2-330
	32.0		RCP1-332	RCP2-332	
	33.7		RCP1-333.7	RCP2-333.7	
	35.0		RCP1-335	RCP2-335	
	38.0	G 1 1/4	1 1/2	RCP1-338	RCP2-338
	40.0		RCP1-340	RCP2-340	
	42.0		RCP1-342	RCP2-342	
4	38.0	G 1 1/4	1 1/2	RCP1-438	RCP2-438
	40.0		RCP1-440	RCP2-440	
	42.0		RCP1-442	RCP2-442	
	45.0	G 1 1/2		RCP1-445	RCP2-445
	48.3			RCP1-448.3	RCP2-448.3
	50.0			RCP1-450	RCP2-450
	51.0	G 2	2	RCP1-451	RCP2-451
	52.0			RCP1-452	RCP2-452
	55.0			RCP1-455	RCP2-455
	57.0			RCP1-457	RCP2-457
	60.3			RCP1-460.3	RCP2-460.3
	63.0			RCP1-463	RCP2-463
	65.0	G 2	2 1/4	RCP1-465	RCP2-465
70.0	RCP1-470			RCP2-470	

Continuation see next page ...

Tube clamps series C – Complete range (Continued)

Order codes for clamp halves:

Material	Interior surface	Order code
Polypropylene	grooved	RCP
	smooth	RCPG ¹⁾
Polyamide	grooved	RCN
	smooth	RCNG ¹⁾
Rubber	grooved	RCVR ¹⁾²⁾
	smooth	RCVG ¹⁾²⁾
Aluminium	grooved	RCA

(Please exchange as required standard abbreviation RCP in column for "Order code")

For flame- or corrosion retardant materials, please refer to page T5.

The steel parts of kits 1 and 2 are phosphated.

Other compositions available on request.

2 clamp halves, weld plate,
cover plate, hex. head bolt

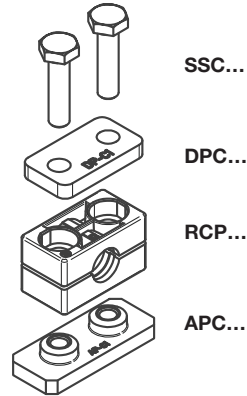

2 clamp halves, weld plate,
cover plate, socket head bolt

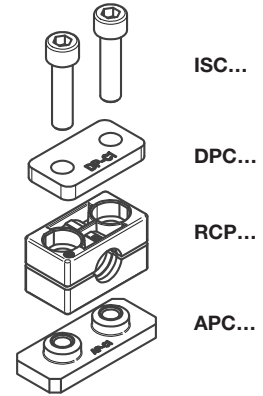

clamp size	Tube O.D. mm	Tube NB	Tube O.D.	Order code	Order code
5	65.0	G 2 1/2	3	RCP1-565	RCP2-565
	70.0			RCP1-570	RCP2-570
	73.0			RCP1-573	RCP2-573
	75.0			RCP1-575	RCP2-575
	76.1			RCP1-576.1	RCP2-576.1
	80.0			RCP1-580	RCP2-580
	82.5	G 3	3 1/4	RCP1-582.5	RCP2-582.5
	85.0			RCP1-585	RCP2-585
	88.0			RCP1-588	RCP2-588
	88.9			RCP1-588.9	RCP2-588.9
90.0	RCP1-590	RCP2-590			
6	90.0	G 3 1/2	4	RCP1-690	RCP2-690
	97.0			RCP1-697	RCP2-697
	100.0			RCP1-6100	RCP2-6100
	101.6			RCP1-6101.6	RCP2-6101.6
	108.0	G 4	4 1/4	RCP1-6108	RCP2-6108
	114.3			RCP1-6114.3	RCP2-6114.3
	115.0			RCP1-6115	RCP2-6115
	120.0	5	4 1/2	RCP1-6120	RCP2-6120
	127.0			RCP1-6127	RCP2-6127
	7	127.0	G 5	5	RCP1-7127
130.0		RCP1-7130			RCP2-7130
133.0		RCP1-7133			RCP2-7133
140.0		RCP1-7140			RCP2-7140
150.0		G 5 1/2	5 1/2	RCP1-7150	RCP2-7150
152.4				RCP1-7152.4	RCP2-7152.4
159.0		G 6	6	RCP1-7159	RCP2-7159
165.1				RCP1-7165.1	RCP2-7165.1
168.3	6 5/8	RCP1-7168.3	RCP2-7168.3		
8	168.3	G 8	6 5/8	RCP1-8168.3	RCP2-8168.3
	177.8		7	RCP1-8177.8	RCP2-8177.8
	190.0		7 5/8	RCP1-8190	RCP2-8190
	193.7			RCP1-8193.7	RCP2-8193.7
	203.0			RCP1-8203	RCP2-8203
	219.1		8 5/8	RCP1-8219.1	RCP2-8219.1
	220.0			RCP1-8220	RCP2-8220
9	219.1	G 8	8 5/8	RCP1-9219.1	RCP2-9219.1
	244.5			RCP1-9244.5	RCP2-9244.5
	273.0	G 10	10 3/4	RCP1-9273	RCP2-9273
	323.9	G 12	12 3/4	RCP1-9323.9	RCP2-9323.9
10	355.6	G 14	14	RCP1-10355.6	RCP2-10355.6
	406.4			G 16	16

Delivery in unassembled individual components.

¹⁾ Only sizes 1–8

²⁾ When assembling solid rubber clamps, covering plates, hexagon screws and locking washers must be used.

Tube clamps

Tube clamps series C – Complete range

Order codes for clamp halves:

Material	Interior surface	Order code
Polypropylene	grooved	RCP
	smooth	RCPG ¹⁾
Polyamide	grooved	RCN
	smooth	RCNG ¹⁾
Rubber	grooved	RCVR ¹⁾²⁾
	smooth	RCVG ¹⁾²⁾
Aluminium	grooved	RCA

(Please exchange as required standard abbreviation RCP in column for "Order code")

For flame- or corrosion retardant materials, please refer to page T5.

The steel parts of kits 3, 4 and 5 have the following surfaces:

Bolts, cover plate, locking plate = phosphated

Rail nuts = Cr(VI)-free galvanized

Other compositions available on request.

2 clamp halves,
rail nuts, cover plate,
hex. head bolts

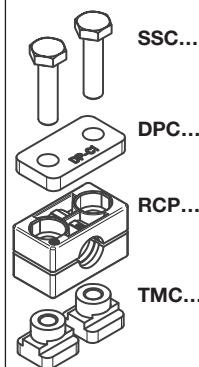

2 clamp halves,
rail nuts, cover plate,
socket head bolts

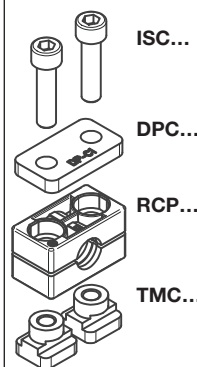

2 clamp halves, lock-
ing plate, stacking
bolts

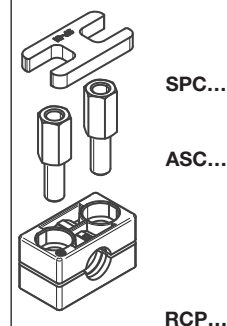

clamp size	Tube O.D. mm	Tube NB	Tube O.D.	Order code	Order code	Order code
1	6.0	G 1/8	5/16	RCP3-106	RCP4-106	RCP5-106
	8.0			RCP3-108	RCP4-108	RCP5-108
	9.5		RCP3-109.5	RCP4-109.5	RCP5-109.5	
	10.0		RCP3-110	RCP4-110	RCP5-110	
	12.0	G 1/4	1/2	RCP3-112	RCP4-112	RCP5-112
	12.7			RCP3-112.7	RCP4-112.7	RCP5-112.7
	13.5		RCP3-113.5	RCP4-113.5	RCP5-113.5	
	14.0		RCP3-114	RCP4-114	RCP5-114	
	15.0	G 3/8	5/8	RCP3-115	RCP4-115	RCP5-115
	16.0			RCP3-116	RCP4-116	RCP5-116
17.2	RCP3-117.2		RCP4-117.2	RCP5-117.2		
18.0	RCP3-118		RCP4-118	RCP5-118		
2	19.0	G 1/2	3/4	RCP3-219	RCP4-219	RCP5-219
	20.0			RCP3-220	RCP4-220	RCP5-220
	21.3		RCP3-221.3	RCP4-221.3	RCP5-221.3	
	22.0		RCP3-222	RCP4-222	RCP5-222	
	23.0	G 3/4	1	RCP3-223	RCP4-223	RCP5-223
	25.0			RCP3-225	RCP4-225	RCP5-225
	25.4		RCP3-225.4	RCP4-225.4	RCP5-225.4	
	26.9		RCP3-226.9	RCP4-226.9	RCP5-226.9	
	28.0	RCP3-228	RCP4-228	RCP5-228		
	30.0			RCP3-230	RCP4-230	RCP5-230
3	30.0	G 1	1 1/4	RCP3-330	RCP4-330	RCP5-330
	32.0			RCP3-332	RCP4-332	RCP5-332
	33.7		RCP3-333.7	RCP4-333.7	RCP5-333.7	
	35.0		RCP3-335	RCP4-335	RCP5-335	
	38.0	G 1 1/4	1 1/2	RCP3-338	RCP4-338	RCP5-338
	40.0			RCP3-340	RCP4-340	RCP5-340
	42.0			RCP3-342	RCP4-342	RCP5-342
4	38.0	G 1 1/4	1 1/2	RCP3-438	RCP4-438	RCP5-438
	40.0			RCP3-440	RCP4-440	RCP5-440
	42.0		RCP3-442	RCP4-442	RCP5-442	
	45.0		RCP3-445	RCP4-445	RCP5-445	
	48.3	G 1 1/2	2	RCP3-448.3	RCP4-448.3	RCP5-448.3
	50.0			RCP3-450	RCP4-450	RCP5-450
	51.0			RCP3-451	RCP4-451	RCP5-451
	52.0	G 2	2 1/4	RCP3-452	RCP4-452	RCP5-452
	55.0			RCP3-455	RCP4-455	RCP5-455
	57.0		RCP3-457	RCP4-457	RCP5-457	
	60.3		RCP3-460.3	RCP4-460.3	RCP5-460.3	
	63.0	2 1/2	2 1/2	RCP3-463	RCP4-463	RCP5-463
	65.0			RCP3-465	RCP4-465	RCP5-465
70.0	RCP3-470			RCP4-470	RCP5-470	

Continuation see next page ...

Tube clamps series C – Complete range (Continued)

Order codes for clamp halves:

Material	Interior surface	Order code
Polypropylene	grooved	RCP
	smooth	RCPG ¹⁾
Polyamide	grooved	RCN
	smooth	RCNG ¹⁾
Rubber	grooved	RCVR ¹⁾²⁾
	smooth	RCVG ¹⁾²⁾
Aluminium	grooved	RCA

(Please exchange as required standard abbreviation RCP in column for "Order code")

For flame- or corrosion retardant materials, please refer to page T5.

The steel parts of kits 5 are phosphated.

Other compositions available on request.

2 clamp halves, locking plate, stacking bolts

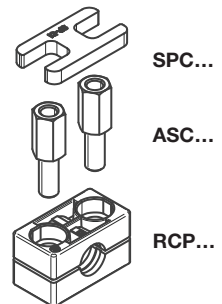

clamp size	Tube O.D. mm	Tube NB	Tube O.D.	Order code			
5	65.0	G 2 1/2	3	RCP5-565			
	70.0			RCP5-570			
	73.0			RCP5-573			
	75.0			RCP5-575			
	76.1			RCP5-576.1			
	80.0			RCP5-580			
	82.5			RCP5-582.5			
	85.0			RCP5-585			
	88.0			RCP5-588			
	88.9			RCP5-588.9			
6	90.0	G 3	3 1/2	RCP5-590			
	97.0			RCP5-690			
	100.0			RCP5-697			
	101.6			RCP5-6100			
	108.0			RCP5-6101.6			
	114.3			RCP5-6108			
	115.0			RCP5-6114.3			
	120.0			RCP5-6115			
	127.0			RCP5-6120			
	7			127.0	G 3 1/2	4	RCP5-6127
130.0		RCP5-6127					
133.0		RCP5-7130					
140.0		RCP5-7133					
150.0		RCP5-7140					
152.4		RCP5-7150					
159.0		RCP5-7152.4					
165.1		RCP5-7159					
168.3		RCP5-7165.1					
8		168.3	G 5	5			RCP5-7168.3
	177.8	RCP5-7168.3					
	190.0	RCP5-8168.3					
	193.7	RCP5-8177.8					
	203.0	RCP5-8177.8					
	219.1	RCP5-8190					
	220.0	RCP5-8190					
	8	168.3			G 5 1/2	6	RCP5-8193.7
		177.8					RCP5-8193.7
		190.0					RCP5-8203
193.7		RCP5-8203					
203.0		RCP5-8219.1					
219.1		RCP5-8219.1					
220.0		RCP5-8219.1					
8		168.3	G 6	6 5/8			RCP5-8220
		177.8					RCP5-8220
		190.0					RCP5-8168.3
	193.7	RCP5-8177.8					
	203.0	RCP5-8177.8					
	219.1	RCP5-8190					
	220.0	RCP5-8190					
	8	168.3			G 6	6 1/4	RCP5-8193.7
		177.8					RCP5-8193.7
		190.0					RCP5-8203
193.7		RCP5-8203					
203.0		RCP5-8219.1					
219.1		RCP5-8219.1					
220.0		RCP5-8219.1					
8		168.3	G 8	8 5/8			RCP5-8220
		177.8					RCP5-8220
		190.0					RCP5-8168.3
	193.7	RCP5-8177.8					
	203.0	RCP5-8177.8					
	219.1	RCP5-8190					
	220.0	RCP5-8190					

Delivery in unassembled individual components.

¹⁾ Only sizes 1–8

²⁾ When assembling solid rubber clamps, covering plates, hexagon screws and locking washers must be used.

Tube clamps

Multiclamp series A

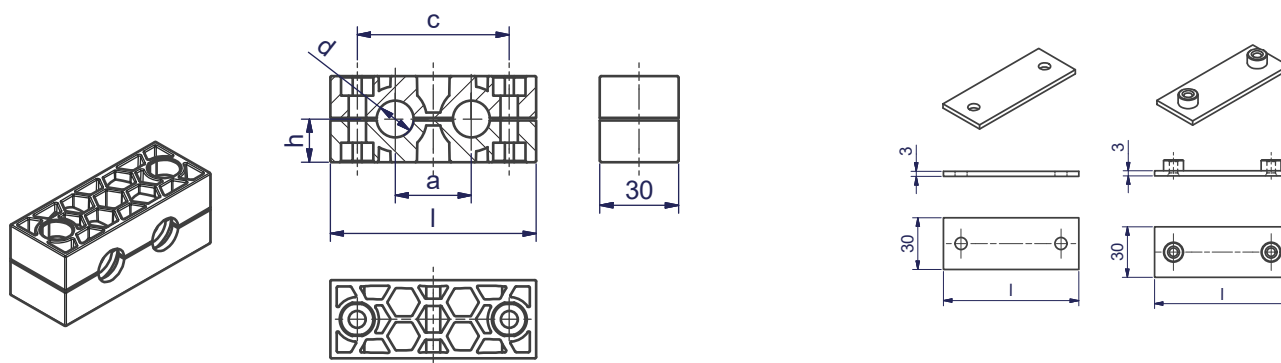

clamp size	Tube O.D. mm d	Number of tubes	Number of Fastening screws B	1 part 2 clamp halves RAPM Order code	2 clamp-halves RAPM-...				cover plate		weld plate	
					a	c	h	l	Order code	length:	Order code	length:
1	6.0	2	2	RAPM106B2X RAPM106.4B2X RAPM108B2X RAPM109.5B2X RAPM110B2X RAPM112B2X	20	40	13.5	60.5	DPM1B2...*	60.5	APM1B2...*	62.5
	6.4											
	8.0											
	9.5											
	10.0											
	12.0											
2	10.0	2	2	RAPM210B2X RAPM212B2X RAPM212.7B2X RAPM213.5B2X RAPM214B2X RAPM215B2X RAPM216B2X RAPM217.2B2X RAPM218B2X	29	58	16.5	78.5	DPM2B2...*	78.5	APM2B2...*	80.5
	12.0											
	12.7											
	13.5											
	14.0											
	15.0											
	16.0											
	17.2											
18.0												
3	15.0	2	2	RAPM315B2X RAPM316B2X RAPM317.2B2X RAPM318B2X RAPM319B2X RAPM320B2X RAPM321.3B2X RAPM322B2X RAPM323B2X RAPM325B2X RAPM325.4B2X	36	72	18.5	92.5	DPM3B2...*	92.5	APM3B2...*	94.5
	16.0											
	17.2											
	18.0											
	19.0											
	20.0											
	21.3											
	22.0											
	23.0											
	25.0											
	25.4											

Order codes for clamp halves:

Material	Interior surface	Order code
Polypropylene	grooved	RAPM
	smooth	RAPGM
Polyamide	grooved	RANM
	smooth	RANGM
Rubber	smooth	RAVGM¹⁾

(Please exchange as required standard abbreviation RAPM in column for "Order code")

For flame- or corrosion retardant materials, please refer to page T5.

Different diameter on request.

¹⁾ When assembling solid rubber clamps, covering plates, hexagon screws and locking washers must be used.

*Please add the suffix below according to the surface/material required.

Order code suffixes		
Surface/material	Suffix	Example
Steel, phosphated	X	DPM1B2X
Steel, zinc plated, Cr(VI)-free	VZX	DPM1B2VZX
Stainless Steel 1.4571	4571X	DPM1B24571X

Multiclamp series A

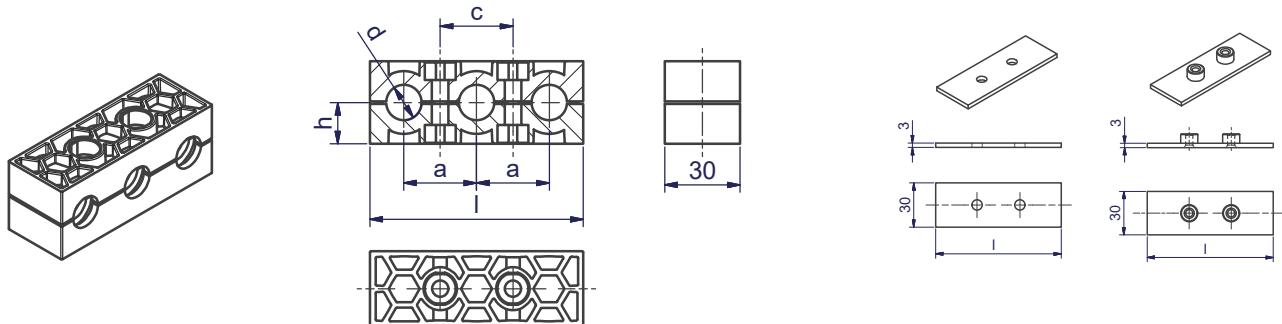

clamp size	Tube O.D. mm d	Number of tubes	Number of Fastening screws B	1 part 2 clamp halves RAPM Order code	2 clamp-halves RAPM-...				cover plate		weld plate	
					a	c	h	l	Order code	length:	Order code	length:
1	6.0	3	2	RAPM106B3X	20	20	13.5	56	DPM1B3...*	56	APM1B3...*	58
	6.4			RAPM106.4B3X								
	8.0			RAPM108B3X								
	9.5			RAPM109.5B3X								
	10.0			RAPM110B3X								
	12.0			RAPM112B3X								
2	10.0	3	2	RAPM210B3X	29	29	16.5	85	DPM2B3...*	85	APM2B3...*	87
	12.0			RAPM212B3X								
	12.7			RAPM212.7B3X								
	13.5			RAPM213.5B3X								
	14.0			RAPM214B3X								
	15.0			RAPM215B3X								
	16.0			RAPM216B3X								
	17.2			RAPM217.2B3X								
	18.0			RAPM218B3X								
3	15.0	3	2	RAPM315B3X	36	36	18.5	106	DPM3B3...*	106	APM3B3...*	108
	16.0			RAPM316B3X								
	17.2			RAPM317.2B3X								
	18.0			RAPM318B3X								
	19.0			RAPM319B3X								
	20.0			RAPM320B3X								
	21.3			RAPM321.3B3X								
	22.0			RAPM322B3X								
	23.0			RAPM323B3X								
	25.0			RAPM325B3X								
	25.4			RAPM325.4B3X								

Order codes for clamp halves:

Material	Interior surface	Order code
Polypropylene	grooved	RAPM
	smooth	RAPGM
Polyamide	grooved	RANM
	smooth	RANGM
Rubber	smooth	RAVGM¹⁾

(Please exchange as required standard abbreviation RAPM in column for "Order code")

For flame- or corrosion retardant materials, please refer to page T5.

Different diameter on request.

¹⁾ When assembling solid rubber clamps, covering plates, hexagon screws and locking washers must be used.

*Please add the suffix below according to the surface/material required.

Order code suffixes		
Surface/material	Suffix	Example
Steel, phosphated	X	DPM1B3X
Steel, zinc plated, Cr(VI)-free	VZX	DPM1B3VZX
Stainless Steel 1.4571	4571X	DPM1B34571X

Multiclamp series A

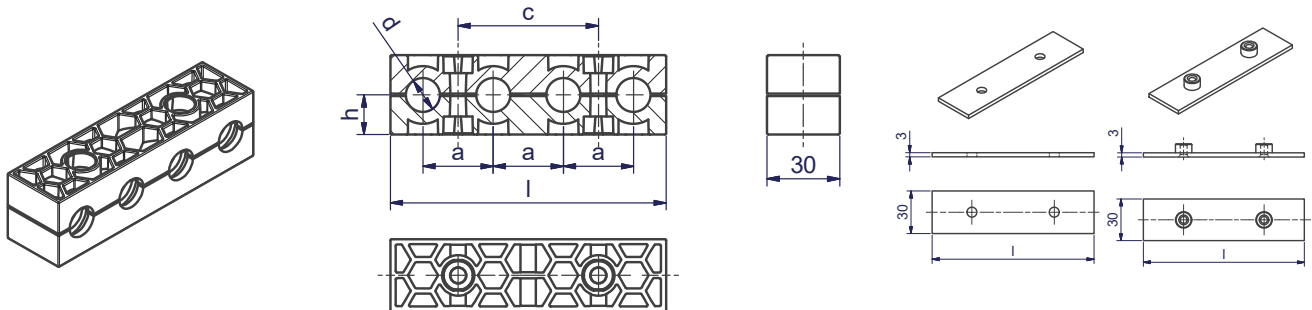

clamp size	Tube O.D. mm d	Number of tubes	Number of Fastening screws B	1 part 2 clamp halves RAPM Order code	2 clamp-halves RAPM-...				cover plate		weld plate	
					a	c	h	l	Order code	length:	Order code	length:
1	6.0	4	2	RAPM106B4X	20	40	13.5	76	DPM1B4...*	76	APM1B4...*	78
	6.4			RAPM106.4B4X								
	8.0			RAPM108B4X								
	9.5			RAPM109.5B4X								
	10.0			RAPM110B4X								
	12.0			RAPM112B4X								
2	10.0	4	2	RAPM210B4X	29	58	16.5	114	DPM2B4...*	114	APM2B4...*	116
	12.0			RAPM212B4X								
	12.7			RAPM212.7B4X								
	13.5			RAPM213.5B4X								
	14.0			RAPM214B4X								
	15.0			RAPM215B4X								
	16.0			RAPM216B4X								
	17.2			RAPM217.2B4X								
	18.0			RAPM218B4X								
3	15.0	4	2	RAPM315B4X	36	72	18.5	142	DPM3B4...*	142	APM3B4...*	144
	16.0			RAPM316B4X								
	17.2			RAPM317.2B4X								
	18.0			RAPM318B4X								
	19.0			RAPM319B4X								
	20.0			RAPM320B4X								
	21.3			RAPM321.3B4X								
	22.0			RAPM322B4X								
	23.0			RAPM323B4X								
	25.0			RAPM325B4X								
	25.4			RAPM325.4B4X								

Order codes for clamp halves:

Material	Interior surface	Order code
Polypropylene	grooved	RAPM
	smooth	RAPGM
Polyamide	grooved	RANM
	smooth	RANGM
Rubber	smooth	RAVGM¹⁾

(Please exchange as required standard abbreviation RAPM in column for "Order code")

For flame- or corrosion retardant materials, please refer to page T5.

Different diameter on request.

¹⁾ When assembling solid rubber clamps, covering plates, hexagon screws and locking washers must be used.

*Please add the suffix below according to the surface/material required.

Order code suffixes		
Surface/material	Suffix	Example
Steel, phosphated	X	DPM1B4X
Steel, zinc plated, Cr(VI)-free	VZX	DPM1B4VZX
Stainless Steel 1.4571	4571X	DPM1B44571X

Multiclamp series A

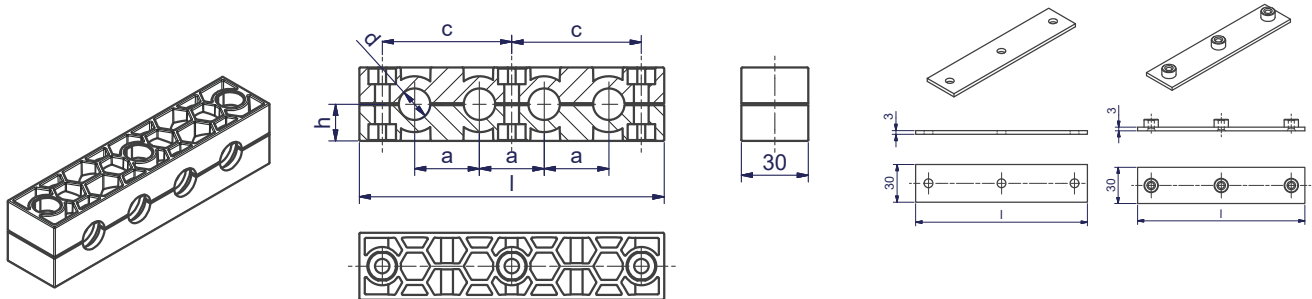

clamp size	Tube O.D. mm d	Number of tubes	Number of Fastening screws C	1 part 2 clamp halves RAPM Order code	2 clamp-halves RAPM-...				cover plate		weld plate	
					a	c	h	l	Order code	length:	Order code	length:
1	6.0	4	3	RAPM106C4X RAPM106.4C4X RAPM108C4X RAPM109.5C4X RAPM110C4X RAPM112C4X	20	40	13.5	100.5	DPM1C4...*	100.5	APM1C4...*	102.5
	6.4											
	8.0											
	9.5											
	10.0											
2	12.0	4	3	RAPM210C4X RAPM212C4X RAPM212.7C4X RAPM213.5C4X RAPM214C4X RAPM215C4X RAPM216C4X RAPM217.2C4X RAPM218C4X	29	58	16.5	136.5	DPM2C4...*	136.5	APM2C4...*	138.5
	10.0											
	12.0											
	12.7											
	13.5											
	14.0											
	15.0											
	16.0											
3	17.2	4	3	RAPM315C4X RAPM316C4X RAPM317.2C4X RAPM318C4X RAPM319C4X RAPM320C4X RAPM321.3C4X RAPM322C4X RAPM323C4X RAPM325C4X RAPM325.4C4X	36	72	18.5	164.5	DPM3C4...*	164.5	APM3C4...*	166.5
	15.0											
	16.0											
	17.2											
	18.0											
	19.0											
	20.0											
	21.3											
	22.0											
	23.0											
25.0												
25.4												

Order codes for clamp halves:

Material	Interior surface	Order code
Polypropylene	grooved	RAPM
	smooth	RAPGM
Polyamide	grooved	RANM
	smooth	RANGM
Rubber	smooth	RAVGM¹⁾

(Please exchange as required standard abbreviation RAPM in column for "Order code")

For flame- or corrosion retardant materials, please refer to page T5.

Different diameter on request.

¹⁾ When assembling solid rubber clamps, covering plates, hexagon screws and locking washers must be used.

*Please add the suffix below according to the surface/material required.

Order code suffixes		
Surface/material	Suffix	Example
Steel, phosphated	X	DPM1C4X
Steel, zinc plated, Cr(VI)-free	VZX	DPM1C4VZX
Stainless Steel 1.4571	4571X	DPM1C44571X

Multiclamp series A

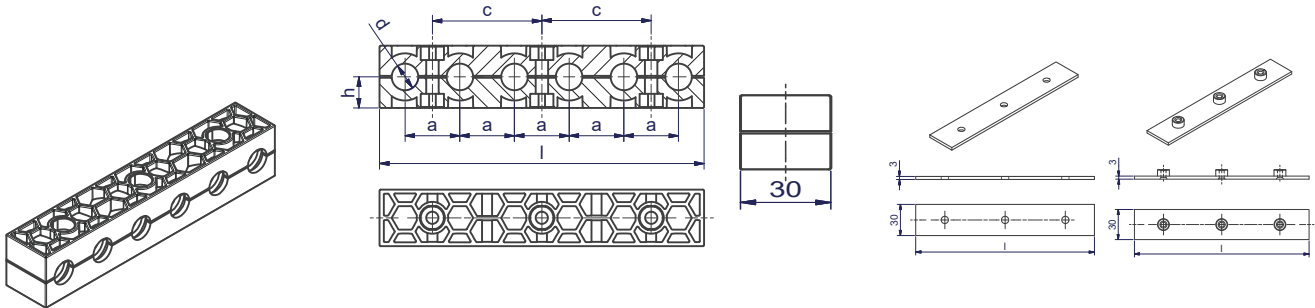

clamp size	Tube O.D. mm d	Number of tubes	Number of Fastening screws C	1 part 2 clamp halves RAPM Order code	2 clamp-halves RAPM-...				cover plate		weld plate	
					a	c	h	l	Order code	length:	Order code	length:
1	6.0	6	3	RAPM106C6X RAPM106.4C6X RAPM108C6X RAPM109.5C6X RAPM110C6X RAPM112C6X	20	40	13.5	116	DPM1C6...*	116	APM1C6...*	118
	6.4											
	8.0											
	9.5											
	10.0											
	12.0											
2	10.0	6	3	RAPM210C6X RAPM212C6X RAPM212.7C6X RAPM213.5C6X RAPM214C6X RAPM215C6X RAPM216C6X RAPM217.2C6X RAPM218C6X	29	58	16.5	172	DPM2C6...*	172	APM2C6...*	174
	12.0											
	12.7											
	13.5											
	14.0											
	15.0											
	16.0											
	17.2											
18.0												
3	15.0	6	3	RAPM315C6X RAPM316C6X RAPM317.2C6X RAPM318C6X RAPM319C6X RAPM320C6X RAPM321.3C6X RAPM322C6X RAPM323C6X RAPM325C6X RAPM325.4C6X	36	72	18.5	214	DPM3C6...*	214	APM3C6...*	216
	16.0											
	17.2											
	18.0											
	19.0											
	20.0											
	21.3											
	22.0											
	23.0											
	25.0											
	25.4											

Order codes for clamp halves:

Material	Interior surface	Order code
Polypropylene	grooved	RAPM
	smooth	RAPGM
Polyamide	grooved	RANM
	smooth	RANGM
Rubber	smooth	RAVGM ¹⁾

(Please exchange as required standard abbreviation RAPM in column for "Order code")

For flame- or corrosion retardant materials, please refer to page T5.

Different diameter on request.

¹⁾ When assembling solid rubber clamps, covering plates, hexagon screws and locking washers must be used.

*Please add the suffix below according to the surface/material required.

Order code suffixes		
Surface/material	Suffix	Example
Steel, phosphated	X	DPM1C6X
Steel, zinc plated, Cr(VI)-free	VZX	DPM1C6VZX
Stainless Steel 1.4571	4571X	DPM1C64571X

Multiclamp series A

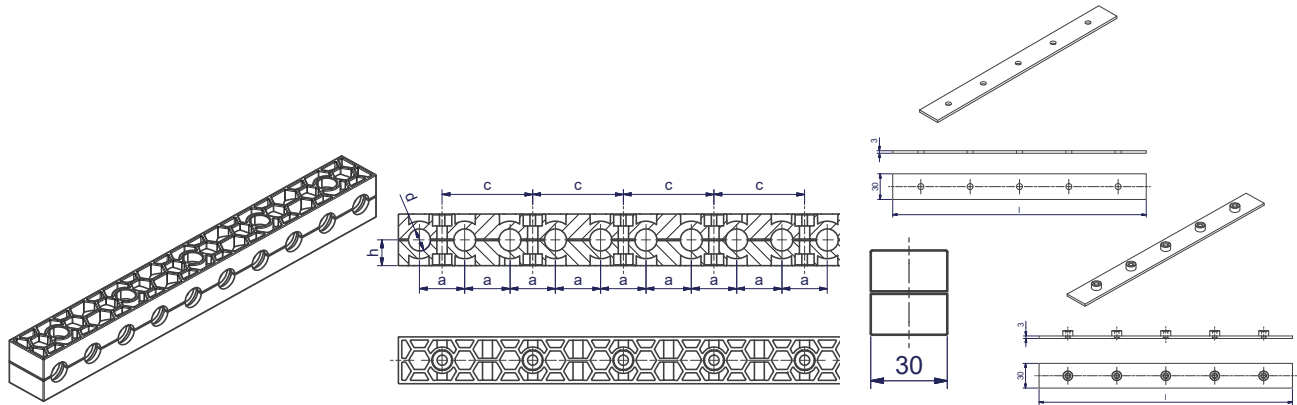

clamp size	Tube O.D. mm d	Number of tubes	Number of Fastening screws C	1 part 2 clamp halves RAPM Order code	2 clamp-halves RAPM-...				cover plate		weld plate	
					a	c	h	l	Order code	length:	Order code	length:
1	6.0	10	5	RAPM106E10X RAPM106.4E10X RAPM108E10X RAPM109.5E10X RAPM110E10X RAPM112E10X	20	40	13.5	196	DPM1E10...*	196	APM1E10...*	198
	6.4											
	8.0											
	9.5											
	10.0											
	12.0											
2	10.0	10	5	RAPM210E10X RAPM212E10X RAPM212.7E10X RAPM213.5E10X RAPM214E10X RAPM215E10X RAPM216E10X RAPM217.2E10X RAPM218E10X	29	58	16.5	288	DPM2E10...*	288	APM2E10...*	300
	12.0											
	12.7											
	13.5											
	14.0											
	15.0											
	16.0											
	17.2											
18.0												
3	15.0	10	5	RAPM315E10X RAPM316E10X RAPM317.2E10X RAPM318E10X RAPM319E10X RAPM320E10X RAPM321.3E10X RAPM322E10X RAPM323E10X RAPM325E10X RAPM325.4E10X	36	72	18.5	358	DPM3E10...*	358	APM3E10...*	360
	16.0											
	17.2											
	18.0											
	19.0											
	20.0											
	21.3											
	22.0											
	23.0											
	25.0											
	25.4											

Order codes for clamp halves:

Material	Interior surface	Order code
Polypropylene	grooved	RAPM
	smooth	RAPGM
Polyamide	grooved	RANM
	smooth	RANGM
Rubber	smooth	RAVGM¹⁾

(Please exchange as required standard abbreviation RAPM in column for "Order code")

For flame- or corrosion retardant materials, please refer to page T5.

Different diameter on request.

¹⁾ When assembling solid rubber clamps, covering plates, hexagon screws and locking washers must be used.

*Please add the suffix below according to the surface/material required.

Order code suffixes		
Surface/material	Suffix	Example
Steel, phosphated	X	DPM1E10X
Steel, zinc plated, Cr(VI)-free	VZX	DPM1E10VZX
Stainless Steel 1.4571	4571X	DPM1E104571X

Tube clamps

Tube clamps series O

Order codes for clamps:

Material	Interior surface	Order code
Polypropylene	smooth	ROP
Polyamide	smooth	RON

Packing standard 100 pieces.

Areas of Application:

- pneumatics
 - automotive technology
 - mechanical engineering
 - measurement and control
 - naval technologie
- also suitable for cables and hoses.

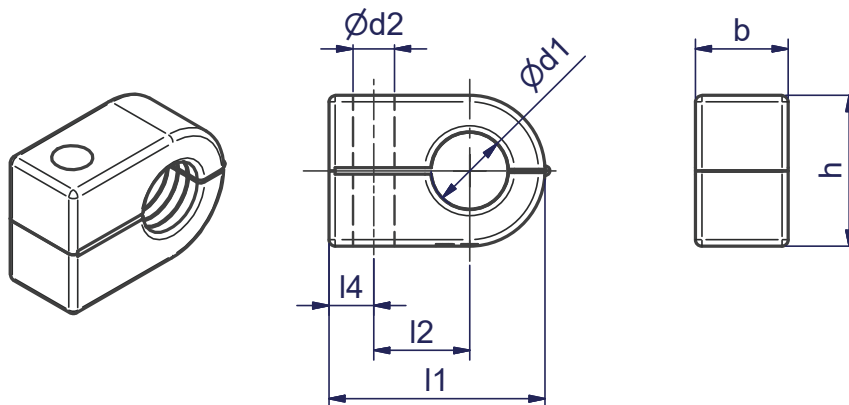

Clamp-size	O.D. mm	Tube Ø d1		Order code		l1	l2	l4	b	H	Ø d2	
		Tube NB	Inch	Polypropylene ROP	Polyamide RON							
1	6.0		1/4	ROP106X	RON106X	23	9	7	14.5	13.5	6.5	
	6.4			ROP106.4X	RON106.4X							
	8.0			ROP108X	RON108X							
2	8.0	G 1/8	3/8	ROP208X	RON208X	27	11	7	14.5	18.5	6.5	
	9.5				ROP209.5X							RON209.5X
	10.0				ROP210X							RON210X
	12.0			ROP212X	RON212X							
	12.7			ROP212.7X	RON212.7X							
3	10.0	G 1/8	1/2	ROP310X	RON310X	34	15	7	14.5	23.5	6.5	
	12.0				ROP312X							RON312X
	12.7	G 1/4	5/8	ROP312.7X	RON312.7X							
	13.5				ROP313.5X							RON313.5X
	14.0				ROP314X							RON314X
	15.0				ROP315X							RON315X
	16.0				ROP316X							RON316X
4	14.0	G 3/8	5/8	ROP414X	RON414X	40	19	6	14.5	30.5	6.5	
	15.0				ROP415X							RON415X
	16.0				ROP416X							RON416X
	17.2				ROP417.2X							RON417.2X
	18.0				ROP418X							RON418X
	19.0	G 1/2	3/4	ROP419X	RON419X							
	20.0				ROP420X							RON420X
	21.3				ROP421.3X							RON421.3X
	22.0				ROP422X							RON422X

Double-Tube clamps series O

Order codes for clamps:

Material	Interior surface	Order code
Polypropylene	smooth	ROPD
Polyamide	smooth	ROND

Different diameter on request.

Packing standard 100 pieces.

Areas of Application:

- pneumatics
 - automotive technology
 - mechanical engineering
 - measurement and control
 - machine tool industry
- also suitable for cables and hoses.

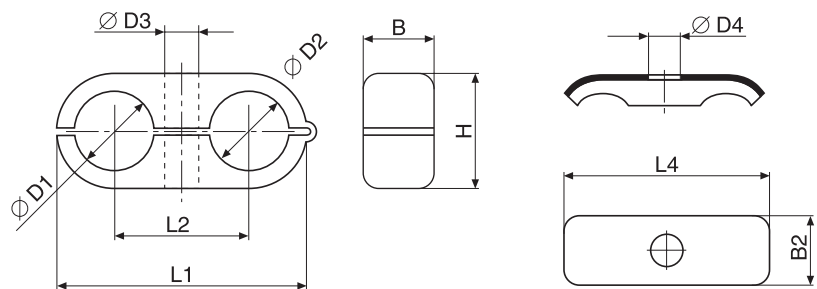
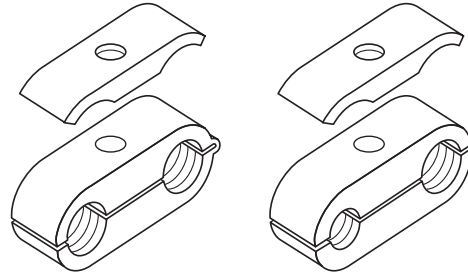

Clamp-size	Tube O.D. D1/D2			Order code		Order code									
	mm	Tube NB	Inch	Polypropylene ROPD	Polyamide ROND	Cover plate DPO	L1	L2	B	H	Ø D3	L4	B2	Ø D4	
1	6.0		1/4	ROPD106X ROPD106.4X ROPD108X	ROND106X ROND106.4X ROND108X	DPO1X¹⁾ DPO14571X	32	18	14.5	13.5	6.5	29.0	16.3	6.5	
	6.4														
	8.0														
2	8.0	1/8	3/8	ROPD208X ROPD209.5X ROPD210X ROPD212X	ROND208X ROND209.5X ROND210X ROND212X	DPO2X¹⁾ DPO24571X	41	22	14.5	18.5	6.5	40.0	16.3	6.5	
	9.5														
	10.0														
	12.0		1/2	ROPD212.7X	ROND212.7X										
	12.7														
3	10.0	1/8	1/2	ROPD310X ROPD312X ROPD312.7X ROPD313.5X	ROND310X ROND312X ROND312.7X ROND313.5X	DPO3X¹⁾ DPO34571X	54	30	14.5	23.5	6.5	50.5	16.5	6.5	
	12.0														
	12.7														
	13.5		1/4	ROPD314X ROPD315X ROPD316X	ROND314X ROND315X ROND316X										
	14.0														
	15.0														
4	16.0	3/8	5/8	ROPD414X ROPD415X ROPD416X ROPD417.2X	ROND414X ROND415X ROND416X ROND417.2X	DPO4X¹⁾ DPO44571X	69	38	14.5	30.5	6.5	63.0	16.5	6.5	
	17.2														
	18.0														
	19.0	3/4	ROPD418X ROPD419X ROPD420X ROPD421.3X ROPD422X	ROND418X ROND419X ROND420X ROND421.3X ROND422X											
	20.0														
	21.3														
	22.0	1/2													

1) Material = Steel, zinc plated, Cr(VI)-free

Hydraulic steel-clamps

Hydraulic steel-clamps

Order code **HSRS-***

W1: steel coating, Cr(VI)-free

* please add. Ø D

HSRS hydraulic steel-clamps are mainly used in the field of building machinery.

The support-block is welded to the machine body or another component either in upend or flat position. The tube-clamp is screwed on.

The robust construction of the clamp has an impact- and vibration-absorbing effect. The small dimension/height of the clamp allows hydraulic cables to be fitted later on – e. g. for installing additional equipment to building machinery.

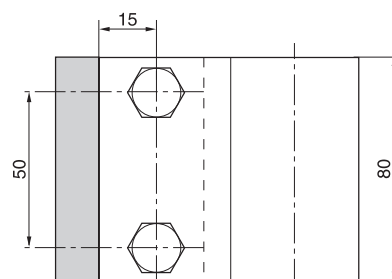
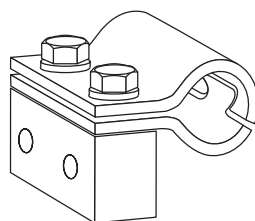
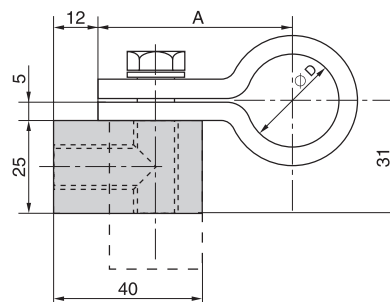
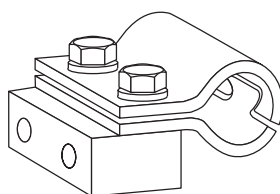

Order code		Dimensions	
Clamp incl. block	Clamp without block	Ø D	A
HSRS25	HSRS3-25CFX	25	52.5
HSRS30	HSRS3-30CFX	30	55.0
HSRS35	HSRS3-35CFX	35	57.5
HSRS38	HSRS3-38CFX	38	59.0
HSRS42	HSRS3-42CFX	42	61.0
HSRS48	HSRS3-48CFX	48	64.0
HSRS50	HSRS3-50CFX	50	65.0
HSRS60	HSRS3-60CFX	60	70.0

M12x30 DIN 933

A12 DIN 127

Hydraulic steel-clamps

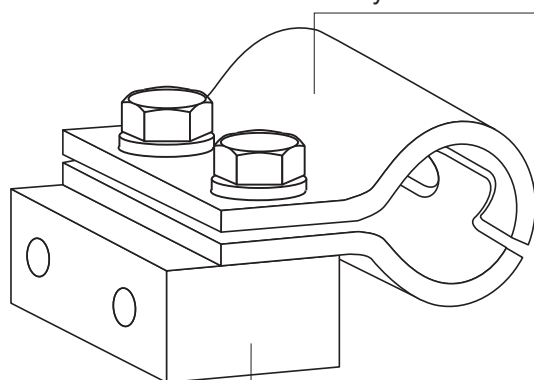

flat

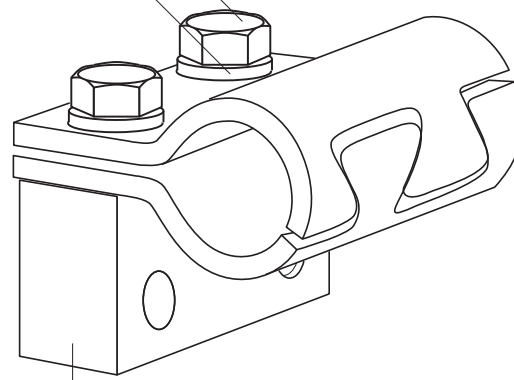

upend

support to welding

Hydraulic steel-clamps

Elastomere Inlay for HSRS

Order code EE-*
 * complete outside tube diameter

Hydraulic steel tube clamp HSRS also available with Elastomere inlay

The advantages:

- complete outside tube diameter
- Safe fastening method even for very sensitive tube and hoses lines
- Only one clamp for different tube diameters

Material:

Santoprene 64 Shore

- high oil and weathering resistance
- temperature stability between -40 °C and +120°C

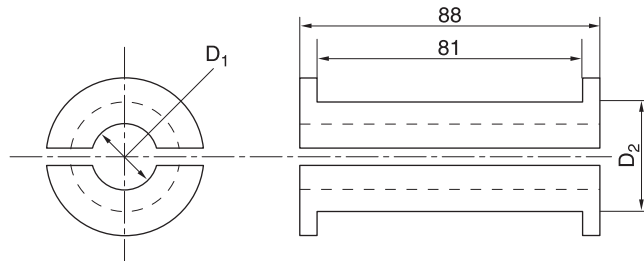

Order code Elastomere inlay	Nominal size D2	mm O.D. D1
EE12X	HSRS25	12
EE15X		15
EE20X	HSRS30	20
EE25X	HSRS35	25
EE30X	HSRS42	30
EE35X	HSRS50	35
EE38X		38
EE42X		42
EE47X	HSRS60	47
EE50X		50

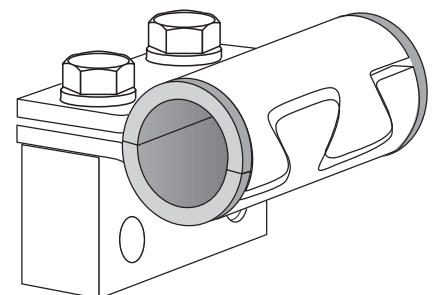
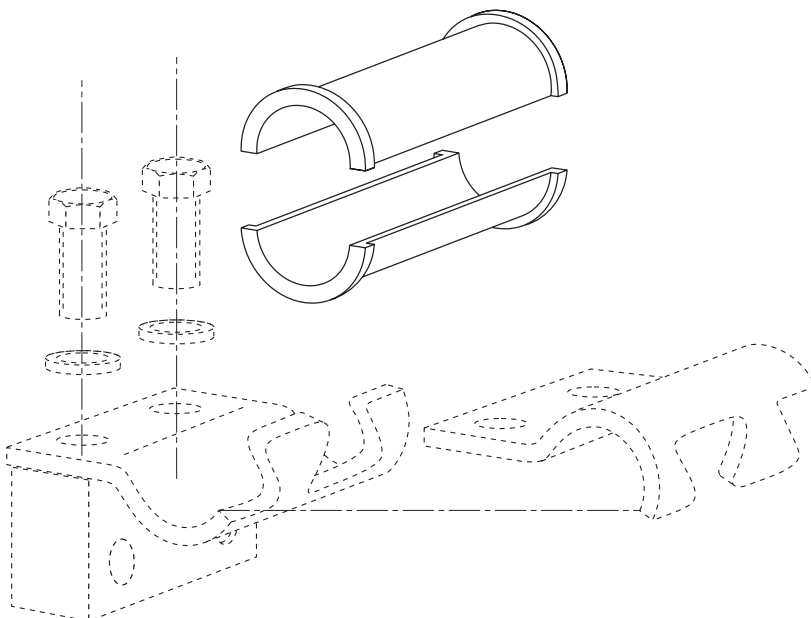

T

Tube Clamps with Elastomer Inlay Serie A

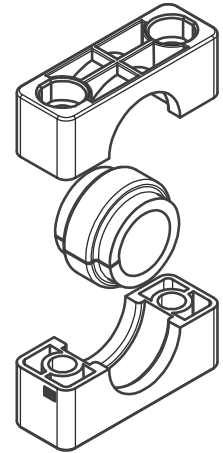

Clamp-halves

Order codes:

Polypropylene – **RAPE**
 Polyamide 6 – **RANE**

If required, replace the standard indicator RAPE in the order code columns.

Elastomer Inlay

Order code:

TPE 73° Shore – **EE***
 *complete with clamp size and outside tube diameter

Clamp size	Tube O.D.	Clamp body	Order code	Elastomer inlay
Serie A	mm		Clamp body with elastomer inlay	
4	6.0	RAPE4X	RAPE406X	EE206/406X
	8.0		RAPE408X	EE208/408X
	10.0		RAPE410X	EE210/410X
	12.0		RAPE412X	EE212/412X
	12.7		RAPE412.7X	EE212.7/412.7X
	14.0		RAPE414X	EE214/414X
	15.0		RAPE415X	EE215/415X
	16.0		RAPE416X	EE216/416X
	17.2		RAPE417.2X	EE217.2/417.2X
	18.0		RAPE418X	EE218/418X
	19.0		RAPE419X	EE219/419X
5	20.0	RAPE5X	RAPE520X	EE520X
	22.0		RAPE522X	EE522X
	25.0		RAPE525X	EE525X
	28.0		RAPE528X	EE528X
	30.0		RAPE530X	EE530X
6	20.0	RAPE6X	RAPE620X	EE320/620X
	21.3		RAPE621.3X	EE321.3/621.3X
	22.0		RAPE622X	EE322/622X
	23.0		RAPE623X	EE323/623X
	25.0		RAPE625X	EE325/625X
	26.9		RAPE626.9X	EE326.9/626.9X
	28.0		RAPE628X	EE328/628X
	30.0		RAPE630X	EE330/630X
	32.0	RAPE632X	EE332/632X	
	35.0	RAPAE6X	RAPE635X	EE635X
	38.0		RAPE638X	EE638X
	42.0		RAPE642X	EE642X
	45.0		RAPE645X	EE645X

Attention! For clamps with elastomer inlay, the relation of diameter and size is not identical with the profile design or smooth design.

Tube Clamps with Elastomer Inlay Serie C

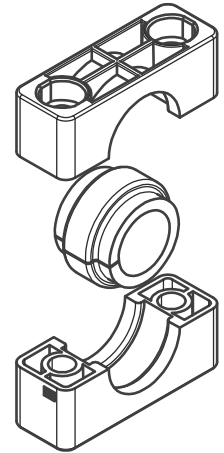

Clamp-halves

Order codes:

Polypropylene – **RCPE**

Polyamide 6 – **RCNE**

If required, replace the standard indicator RCPE in the order code columns.

Elastomer Inlay

Order code:

TPE 73° Shore – **EE***

*complete with clamp size and outside tube diameter

Clamp size Serie C	Tube O.D. mm	Clamp body	Order code Clamp body with elastomer inlay	Elastomer inlay
2	6.0	RCPE2X	RCPE206X	EE206/406X
	8.0		RCPE208X	EE208/408X
	10.0		RCPE210X	EE210/410X
	12.0		RCPE212X	EE212/412X
	12.7		RCPE212.7X	EE212.7/412.7X
	14.0		RCPE214X	EE214/414X
	15.0		RCPE215X	EE215/415X
	16.0		RCPE216X	EE216/416X
	17.2		RCPE217.2X	EE217.2/417.2X
	18.0		RCPE218X	EE218/418X
19.0	RCPE219X	EE219/419X		
3	20.0	RCPE3X	RCPE320X	EE320/620X
	21.3		RCPE321.3X	EE321.3/621.3X
	22.0		RCPE322X	EE322/622X
	23.0		RCPE323X	EE323/623X
	25.0		RCPE325X	EE325/625X
	26.9		RCPE326.9X	EE326.9/626.9X
	28.0		RCPE328X	EE328/628X
	30.0		RCPE330X	EE330/630X
	32.0		RCPE332X	EE332/632X
	4		32.0	RCPE4X
33.7		RCPE433.7X	EE433.7X	
35.0		RCPE435X	EE435X	
38.0		RCPE438X	EE438X	
40.0		RCPE440X	EE440X	
42.0		RCPE442X	EE442X	
45.5		RCPE445.5X	EE445.5X	
48.0		RCPE448X	EE448X	
51.0		RCPE451X	EE451X	
53.4		RCPE453.4	EE453.4X	
56.4	RCPE456.4X	EE456.4X		
60.3	RCPE460.3X	EE460.3X		
5	57.0	RCPE5X	RCPE557X	EE557X
	60.3		RCPE560.3X	EE560.3X
	63.5		RCPE563.5X	EE563.5X
	65.0		RCPE565X	EE565X
	70.0		RCPE570X	EE570X
	73.0		RCPE573X	EE573X
76.1	RCPE576.1X	EE576.1X		

Attention! For clamps with elastomer inlay, the relation of diameter and size is not identical with the profile design or smooth design.

Tube Clamps with Elastomer Inlay Serie C

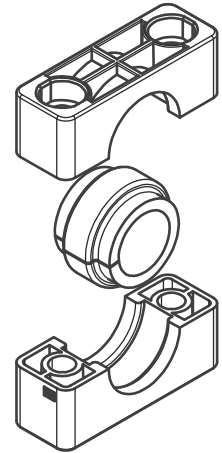

Clamp-halves

Order codes:

Polypropylene – **RCPE**
 Polyamide 6 – **RCNE**

If required, replace the standard indicator RCPE in the order code columns.

Elastomer Inlay

Order code:

TPE 73° Shore – **EE***
 *complete with clamp size and outside tube diameter

Clamp size Serie C	Tube O.D. mm	Order code		
		Clamp body	Clamp body with elastomer inlay	Elastomer inlay
6	80.0	RCPE6X	RCPE680X	EE680X
	82.5		RCPE682.5X	EE682.5X
	88.9		RCPE688.9X	EE688.9X
	100.0		RCPE6100X	EE6100X
	101.6		RCPE6101.6X	EE6101.6X
7	101.6	RCPE7X	RCPE7101.6X	EE7101.6X
	108.0		RCPE7108X	EE7108X
	114.3		RCPE7114.3X	EE7114.3X
	127.0		RCPE7127X	EE7127X
	133.0		RCPE7133X	EE7133X

Attention! For clamps with elastomer inlay, the relation of diameter and size is not identical with the profile design or smooth design.

Fixed Adaptor

Compatibility with channel rails

Hilti (Channel system MQ for medium load)	Halfen (Medium duty channel system)	Unistrut®
MQ-21, MQ-21U, MQ-21D	HM 41/22, HL 41/22, HM 41/22 D	P1000, P1000T, P1001, P1001T
MQ-31	HZM 41/22, HZL 41/22, HZM 41/22 D	P2000, P2000T
MQ-41, MQ-41U, MQ-41D	HM 41/41, HL 41/41, HM 41/41 D	P3300, P3300T10, P3301, P3301T10
MQ-52, MQ-52-72D	HZM 41/41, HZL 41/41, HZM 41/41 D	P4000, P4000T10
MQ-72, MQ-72U	HM 41/62, HL 41/62, HM 41/62 D	P5000T, P5001T, P5500T, P5501T
	HM 41/83, HL 41/83	

Please contact us to check compatibility with additional types of channel rails.

Fixed Adaptor for Series A

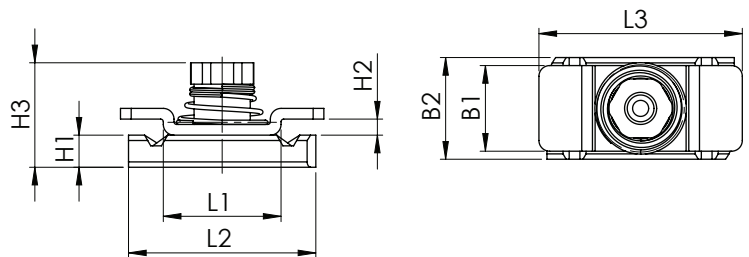
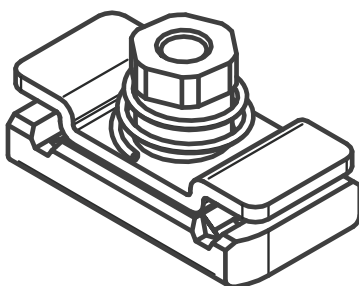

clamp size	Fixed adaptor BAA/BAB Order code	dimensions:								
		L1	L2	L3	B1	B2	H1	H2	H3	d6
1	BAA/BAB1VZX BAA/BAB14571X	22	35	38	16	19	6	3	19.5	M6
2										
3										
4										
5										
6										
7										
8										

Fixed Adaptor for Series B

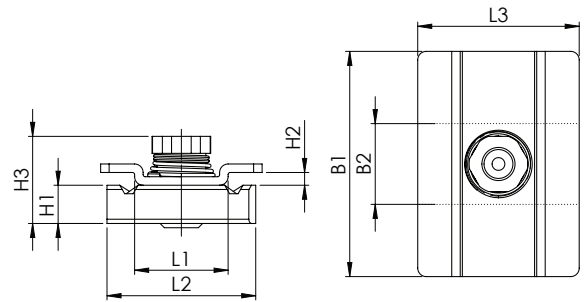
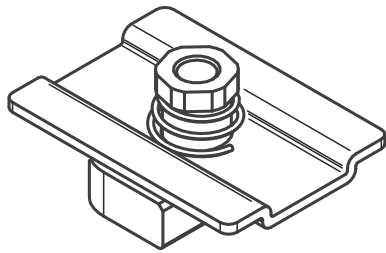

clamp size	Fixed adaptor BAB Order code	dimensions:								
		L1	L2	L3	B1	B2	H1	H2	H3	d6
1	BAA/BAB1VZX BAA/BAB14571X	22	35	38	16	19	6	3	23.5	M6
2	BAB2VZX BAB24571X				53		9			
3										
4	BAB4VZX BAB44571X				80					
5										

Fixed Adaptor for Series C

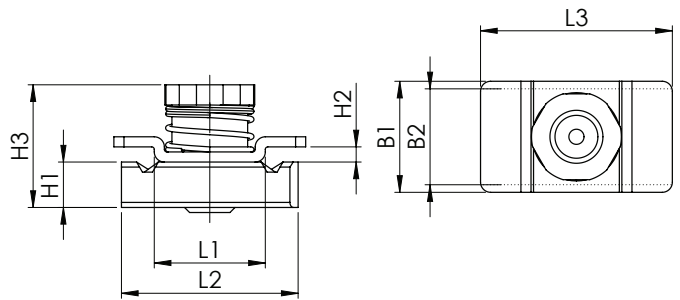
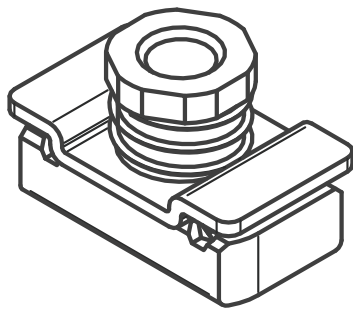

clamp size	Fixed adaptor BAC Order code	dimensions:								
		L1	L2	L3	B1	B2	H1	H2	H3	d6
1	BAC1VZX BAC14571X	22	35	38	22	19	9	3	24.3	M10
2										
3										
4	BAC4VZX BAC44571X			45	25				25.8	M12

Recommended screw lengths when using fixed adaptor for series C

clamp size	Hexagon head screw (with cover plate)	Hexagon socket head screw (without cover plate)	Stacking bolt
1	M10 x 40	M10 x 20*	M10 x 20*
2	M10 x 55*	M10 x 35*	M10 x 35*
3	M10 x 65*	M10 x 50*	M10 x 50*
4	M12 x 100	M12 x 75*	M12 x 75*

*For screws with special length (different from catalogue) price on request.

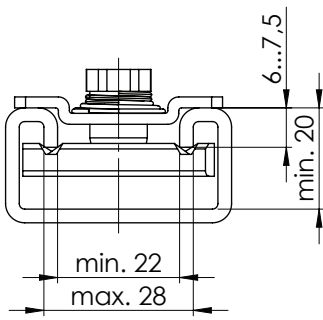

Railnut with loss protection

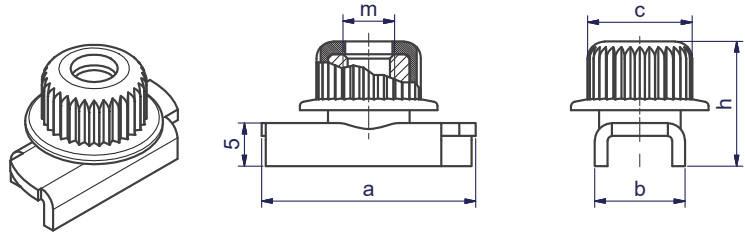

Rail nut light series TMA/B1 Order code	Dimensions:				
	a	b	c	m	h
TMA/TMB1WLPVZX	24.9	10.5	12	M6	14.5
TMA/TMB1WLP71X	24.9	10.5	12	M6	14.5

The big flange prevents that the railnut falls into the rail during installation and has a vibration and sound insulating function.

The rubbercap has an integrated screw locking device. Fast and easy to install, easy to adjust, especially for vertical installations.

Advantages:

- 40% time savings during installation
- Fast and easy to install
- Vibration and sound insulating function
- Especially for vertical installations